

## Specifications

- Voltage rating: 125V AC, DC
- Current Rating: 1A, AC, DC
- Withstand voltage: 250V AC/minute
- Contact resistance: 40mΩ max
- Insulation resistance: 100MΩ min
- Temperature range: -40°C ~ +105°C
- Compliant with RoHS and REACH
- Contact JVT for details

## Assembly layout

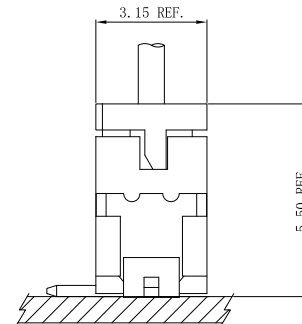
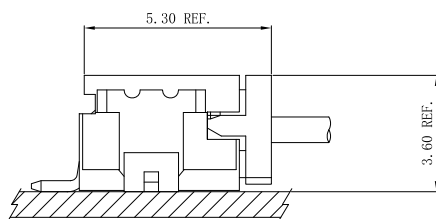
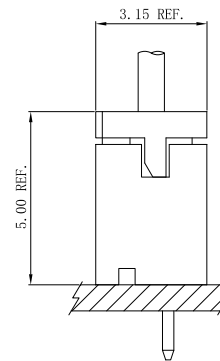
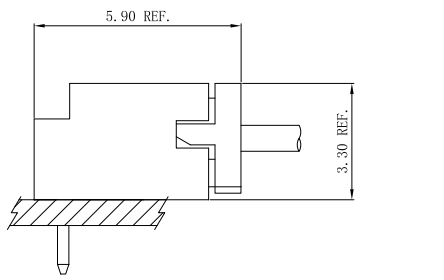

**JVT1146/1147 SERIES**

1.25mm pitch wire to board connector

**JVT1146H**

1.25mm Pitch housing

HOUSING

Part No. : JVT1146HN0-XXN

Material: Nylon 66 UL94V-0

Mates With Part(s): JVT1146 Terminal

JVT1146HN0-XXN

Logo  
Series NO.  
Housing

With nicks  
Pin NO.  
NO-PA66 UL94V-0

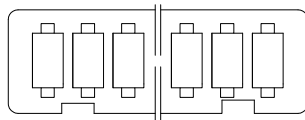
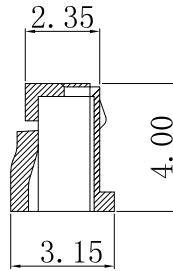
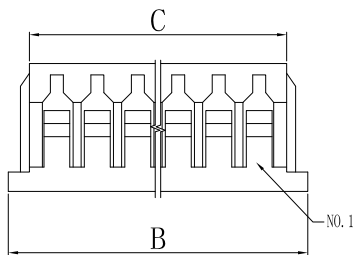
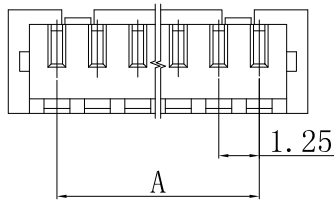

Poles	Dimensions (mm)		
	A	B	C
02	1.25	4.20	2.95
03	2.50	5.50	4.20
04	3.75	6.70	5.45
05	5.00	8.00	6.70
06	6.25	9.20	7.95
07	7.50	10.50	9.20
08	8.75	11.70	10.45
09	10.00	13.00	11.70
10	11.25	14.20	12.95
11	12.50	15.50	14.20
12	13.75	16.70	15.45
13	15.00	18.00	16.70
14	16.25	19.20	17.95
15	17.50	20.50	19.20
16	18.75	21.70	20.45

Unit:mm

**JVT1146H**

1.25mm Pitch housing

HOUSING

Part No. : JVT1146HXX-XX

Material: PA66/PBT UL94V-0

Mates With Part(s): JVT1146 Terminal

JVT1146HXX-XX

Logo  
Series NO.  
Housing

Pin NO.  
NO-PA66 UL94V-0  
PT-PBT UL94V-0

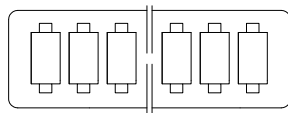
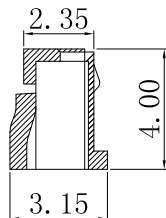
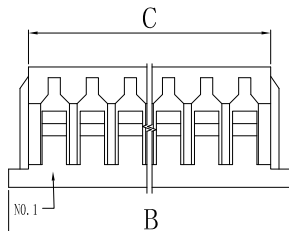
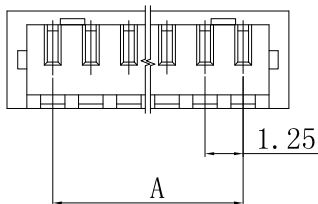

Poles	Dimensions (mm)		
	A	B	C
02	1.25	4.20	2.95
03	2.50	5.50	4.20
04	3.75	6.70	5.45
05	5.00	8.00	6.70
06	6.25	9.20	7.95
07	7.50	10.50	9.20
08	8.75	11.70	10.45
09	10.00	13.00	11.70
10	11.25	14.20	12.95
11	12.50	15.50	14.20
12	13.75	16.70	15.45
13	15.00	18.00	16.70
14	16.25	19.20	17.95
15	17.50	20.50	19.20
16	18.75	21.70	20.45

Unit:mm

JVT1146HN0-XX	PA66 UL94V-0	JVT1146TP-SNS-01
JVT1146HPT-XX	PBT UL94V-0	JVT1146TP-SNS-01
PART NO	Material	Mates With Part(s)

**JVT1146/1147 SERIES**

1.25mm pitch wire to board connector

**JVT1147W**

1.25mm Pitch Wafer-SMT TYPE

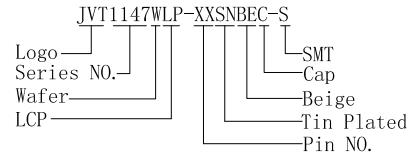
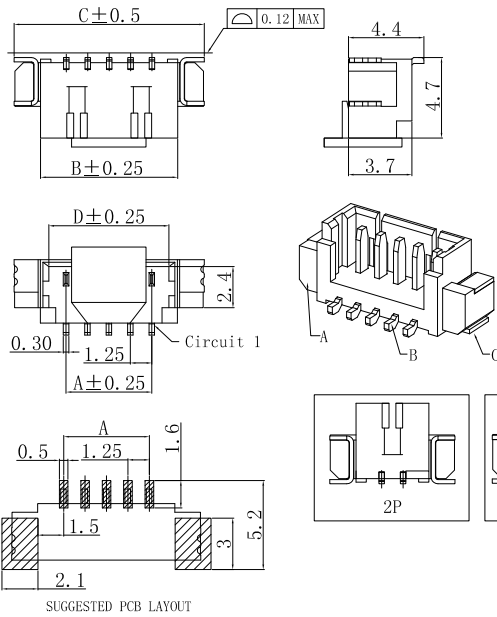

Poles	Dimensions (mm)			
	A	B	C	D
02	1.25	4.25	7.75	3.20
03	2.50	5.50	9.00	4.45
04	3.75	6.75	10.25	5.70
05	5.00	8.00	11.50	6.95
06	6.25	9.25	12.75	8.20
07	7.50	10.50	14.00	9.45
08	8.75	11.75	15.25	10.70
09	10.00	13.00	16.50	11.95
10	11.25	14.25	17.75	13.20
11	12.50	15.50	19.00	14.45
12	13.75	16.75	20.25	15.70
13	15.00	18.00	21.50	16.95
14	16.25	19.25	22.75	18.20
15	17.50	20.50	24.00	19.45
16	18.75	21.75	25.25	20.70

Unit:mm

JVT1147WLP-XXSNBEC-S	LCP UL94V-0	Phos Bronze	Tin Plated	Brass	Tin Plated	JVT1146 Housing
PART NO	Material	Material(Pin)	Finish(Pin)	Material (Solder Tabs)	Finish (Solder Tabs)	Mates With Part(s)

**JVT1146T**

1.25mm Pitch Crimp Terminal

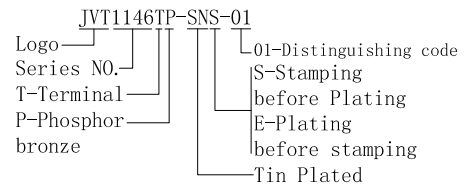
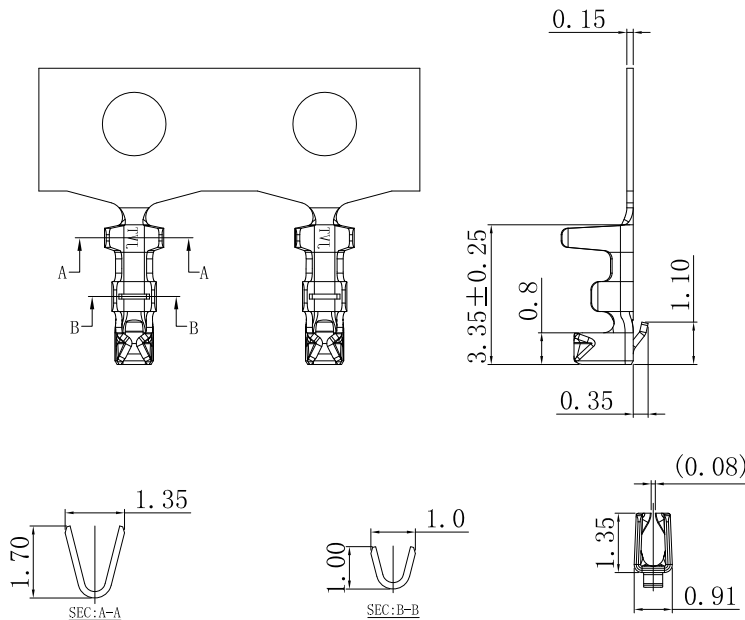

JVT1146TP-SNS	Phos Bronze	Tin Plated	AWG#28~32	0.9mm(Max)	JVT1146 Housing
PART NO	Material	Finish(Pin)	Wire Range	Insulation O.D.	Mates With Part(s)

**JVT1146/1147 SERIES**

1.25mm pitch wire to board connector

**JVT1147W**

1.25mm Pitch 90°Wafer-SMT TYPE

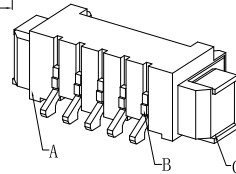
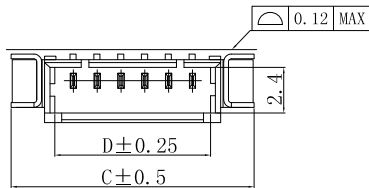
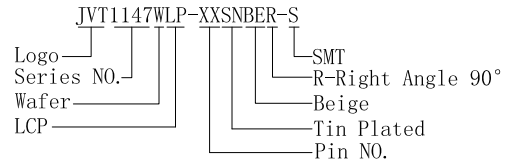
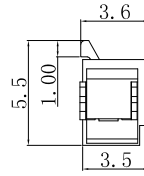
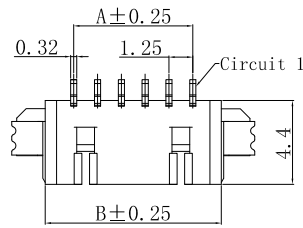

Poles	Dimensions (mm)			
	A	B	C	D
02	1.25	4.25	7.75	3.20
03	2.50	5.50	9.00	4.45
04	3.75	6.75	10.25	5.70
05	5.00	8.00	11.50	6.95
06	6.25	9.25	12.75	8.20
07	7.50	10.50	14.00	9.45
08	8.75	11.75	15.25	10.70
09	10.00	13.00	16.50	11.95
10	11.25	14.25	17.75	13.20
11	12.50	15.50	19.00	14.45
12	13.75	16.75	20.25	15.70
13	15.00	18.00	21.50	16.95
14	16.25	19.25	22.75	18.20
15	17.50	20.50	24.00	19.45
16	18.75	21.75	25.25	20.70

Unit:mm

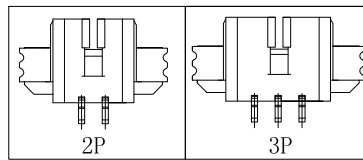
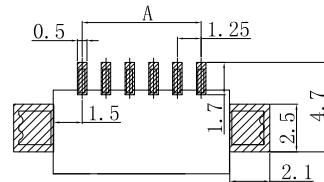

JVT1147WLP-XXSNBER-S	LCP UL94V-0	Phos Bronze	Tin Plated	Brass	Tin Plated	JVT1146 Housing
PART NO	Material	Material(Pin)	Finish(Pin)	Material (Solder Tabs)	Finish (Solder Tabs)	Mates With Part(s)

**JVT1147W**

1.25mm Pitch Wafer-DIP TYPE

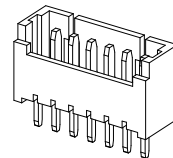
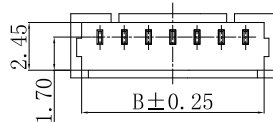
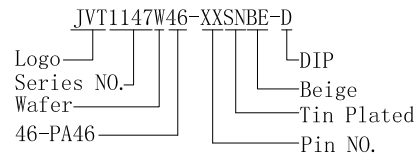
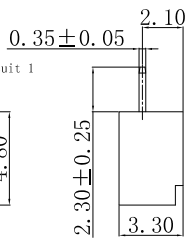
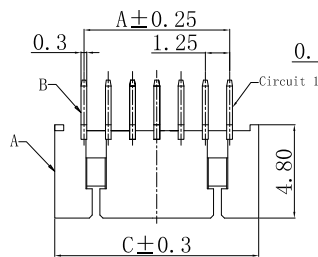

Poles	Dimensions (mm)		
	A	B	C
02	1.25	3.20	4.25
03	2.50	4.45	5.50
04	3.75	5.70	6.75
05	5.00	6.95	8.00
06	6.25	8.20	9.25
07	7.50	9.45	10.50
08	8.75	10.70	11.75
09	10.00	11.95	13.00
10	11.25	13.20	14.25
11	12.50	14.45	15.50
12	13.75	15.70	16.75
13	15.00	16.95	18.00
14	16.25	18.20	19.25
15	17.50	19.45	20.50
16	18.75	20.70	21.75

Unit:mm

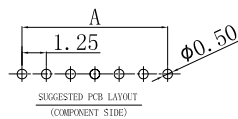
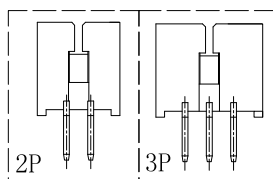

JVT1147WLP-XXSNBE-D	LCP UL94V-0	Brass	Tin Plated	JVT1146 Housing
JVT1147W46-XXSNBE-D	PA46 UL94V-0			JVT1146 Housing
PART NO	Material	Material(Pin)	Finish(Pin)	Mates With Part(s)

**JVT1146/1147 SERIES** 1.25mm pitch wire to board connector

JVT1147W

1.25mm Pitch 90° Wafer-DIP TYPE

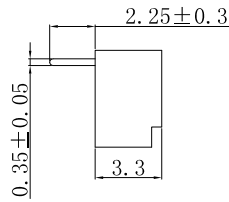
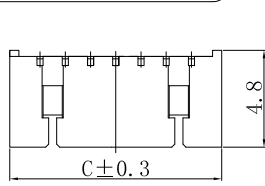

JVT1147WXY-XXSNBER-D  
 Logo Series NO. Wafer LP-LCP UL94V-0 46-PA46 UL94V-0  
 DIP R-Right Angle 90° BE-Beige SN-Tin Plated Pin NO.

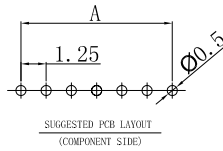
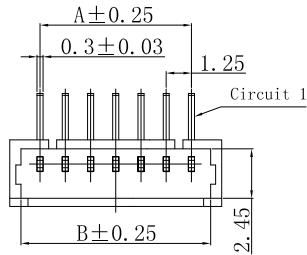

Poles	Dimensions (mm)		
	A	B	C
02	1.25	3.20	4.25
03	2.50	4.45	5.50
04	3.75	5.70	6.75
05	5.00	6.95	8.00
06	6.25	8.20	9.25
07	7.50	9.45	10.50
08	8.75	10.70	11.75
09	10.00	11.95	13.00
10	11.25	13.20	14.25
11	12.50	14.45	15.50
12	13.75	15.70	16.75
13	15.00	16.95	18.00
14	16.25	18.20	19.25
15	17.50	19.45	20.50
16	18.75	20.70	21.75

Unit:mm

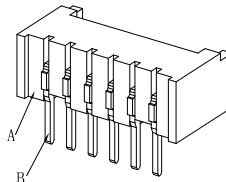
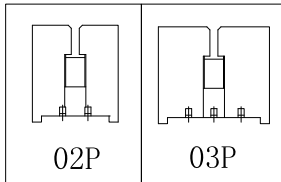

JVT1147WLP-XXSNBE-D	LCP UL94V-0	Brass	Tin Plated	JVT1146 Housing
JVT1147W46-XXSNBE-D	PA46 UL94V-0			JVT1146 Housing
PART NO	Material	Material(Pin)	Finish(Pin)	Mates With Part(s)