

Specifications

- Voltage rating: 400V AC, DC
 - Current Rating: 14A, AC, DC
 - Withstand voltage: 1800V AC/minute
 - Contact resistance: 10m Ω max
 - Insulation resistance: 100M Ω min
 - Temperature range: -40 $^{\circ}$ C ~ +105 $^{\circ}$ C
 - Suitable JVT3503H series Housing
 - JVT3503T series Terminal
 - Compliant with RoHS and REACH
- Contact JVT for details

JVT3503/3504 SERIES 3.5mm pitch wire to board connector

JVT3503H

3.5mm Pitch housing

HOUSING

Part No. : JVT3503H4T-XXXXL-X
Material: PA4T UL94V-0
Mates With Part(s) : JVT3503 Terminal

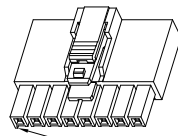
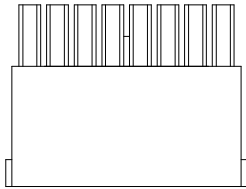
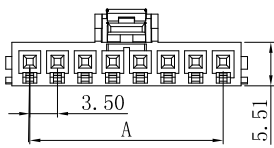
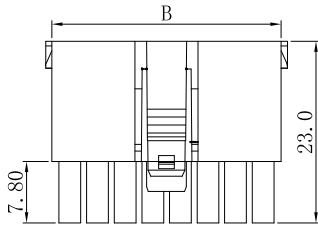

Standard, B KEY

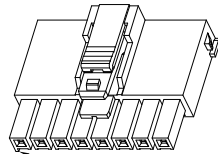

TPA Type, B KEY

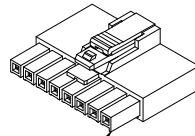

Standard, A KEY

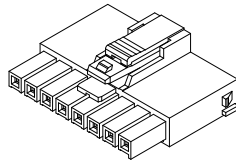

TPA Type, A KEY

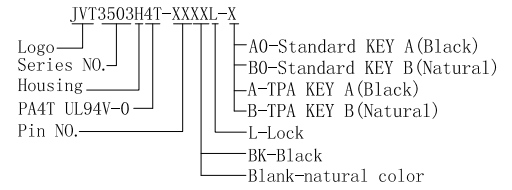

NO.	DIM	
	A	B
02	3.50	8.00
03	7.00	11.50
04	10.50	15.00
05	14.00	18.50
06	17.50	22.00
07	21.00	25.50
08	24.50	29.00

Part No.	Feature	Color
JVT3503H4T-XXBKL-A0	Standard KEY A	Black
JVT3503H4T-XXL-B0	Standard KEY B	Natural
JVT3503H4T-XXBKL-A	TPA KEY A	Black
JVT3503H4T-XXL-B	TPA KEY B	Natural

JVT3503H

3.5mm Pitch housing

HOUSING

Part No. : JVT3503H4T-2*XXXXL-X
Material: PA4T UL94V-0
Mates With Part(s) : JVT3503 Terminal

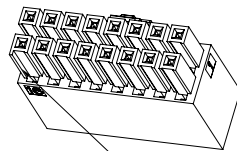
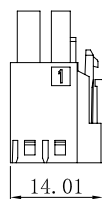
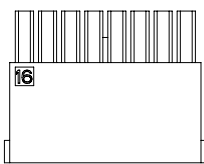
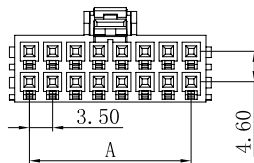
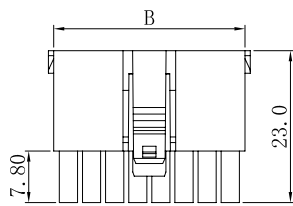

Standard, B KEY

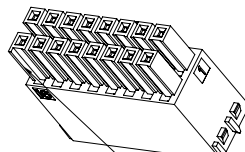

TPA Type, B KEY

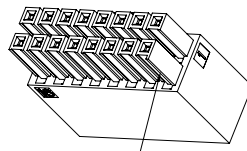

Standard, A KEY

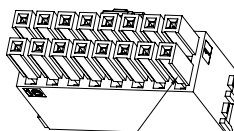

TPA Type, A KEY

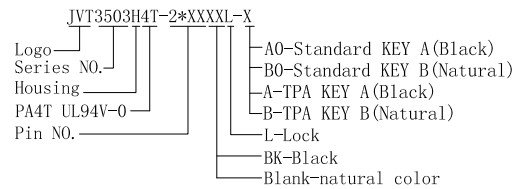

NO.	DIM	
	A	B
2*02	3.50	8.00
2*03	7.00	11.50
2*04	10.50	15.00
2*05	14.00	18.50
2*06	17.50	22.00
2*07	21.00	25.50
2*08	24.50	29.00

Part No.	Feature	Color
JVT3503H4T-2*XXBKL-A0	Standard KEY A	Black
JVT3503H4T-2*XXL-B0	Standard KEY B	Natural
JVT3503H4T-2*XXBKL-A	TPA KEY A	Black
JVT3503H4T-2*XXL-B	TPA KEY B	Natural

JVT3503/3504 SERIES 3.5mm pitch wire to board connector

JVT3503T — 3.5mm Pitch Crimp Terminal

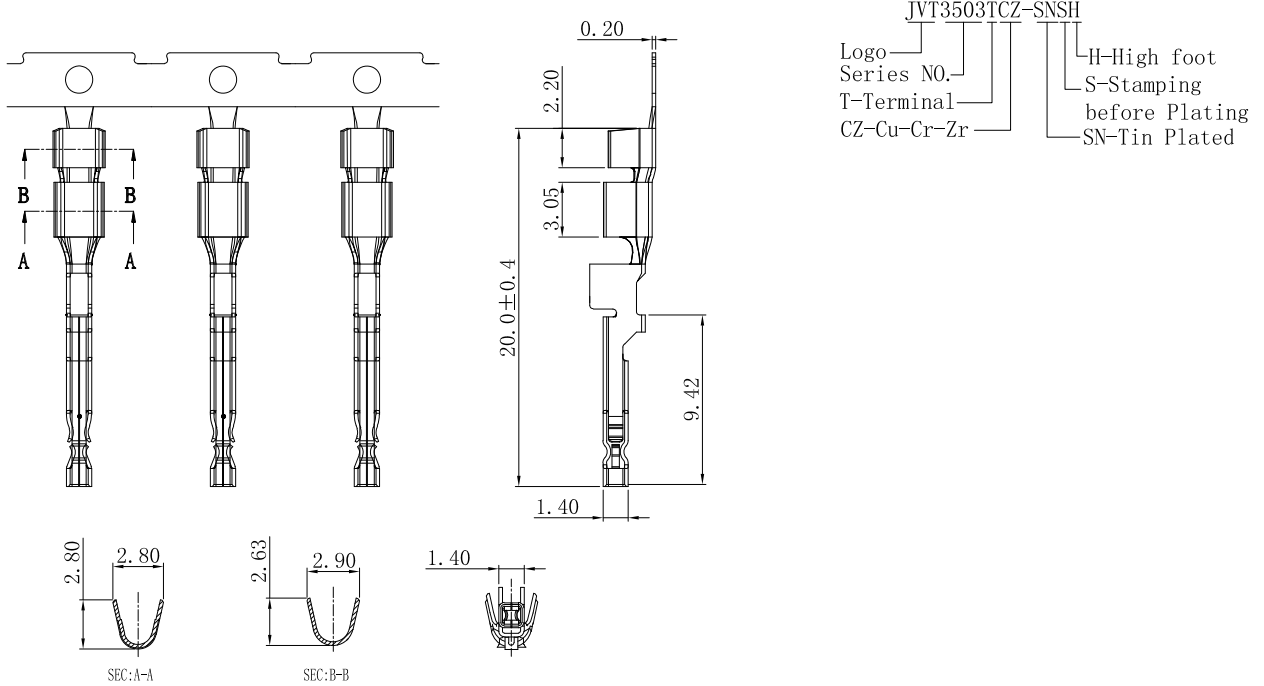

JVT3503TCZ-SNSH	Cu-Cr-Zr	Tin Plated	AWG#16~18	2.39mm (Max)	JVT3503 Housing
PART NO	Material	Finish (Pin)	Wire Range	Insulation O.D.	Mates With Part(s)

JVT3503T — 3.5mm Pitch Crimp Terminal

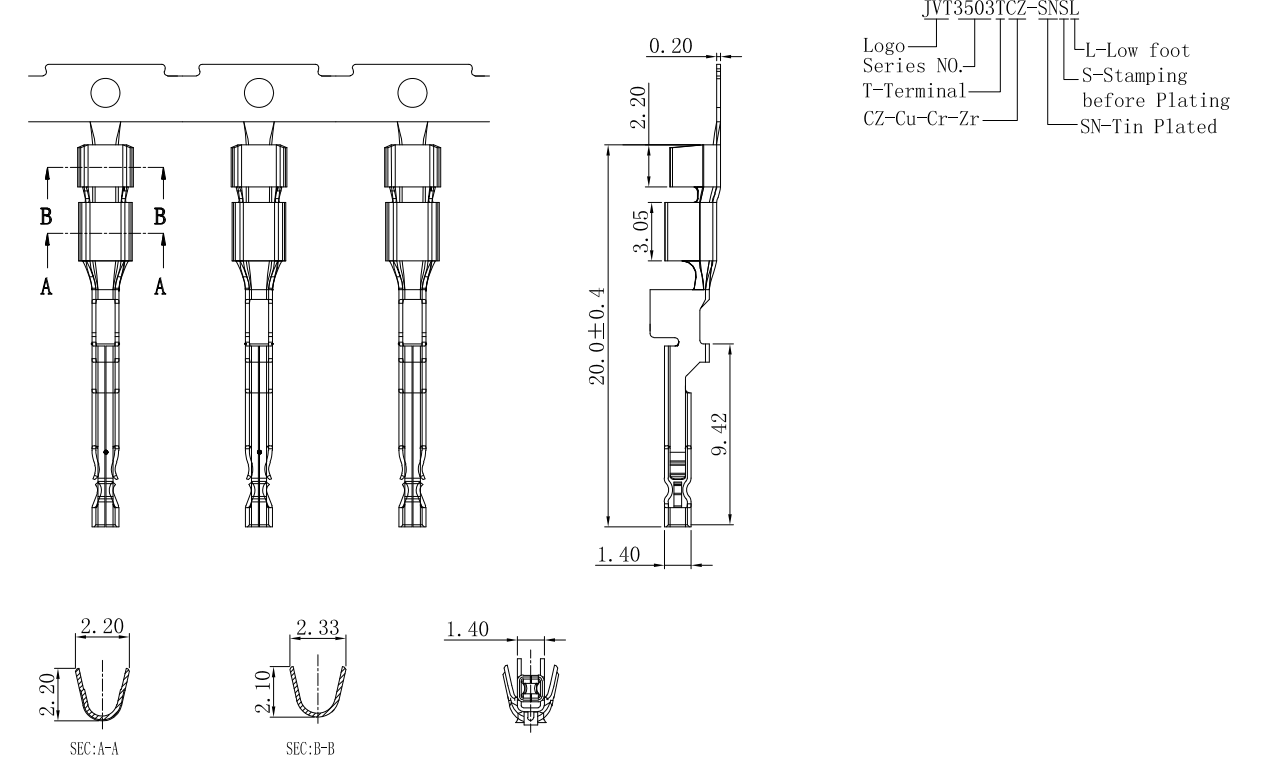

JVT3503TCZ-SNSL	Cu-Cr-Zr	Tin Plated	AWG#20~22	1.80mm (Max)	JVT3503 Housing
PART NO	Material	Finish (Pin)	Wire Range	Insulation O.D.	Mates With Part(s)

JVT3503/3504 SERIES 3.5mm pitch wire to board connector

JVT3504W

3.5mm Pitch Wafer-DIP TYPE

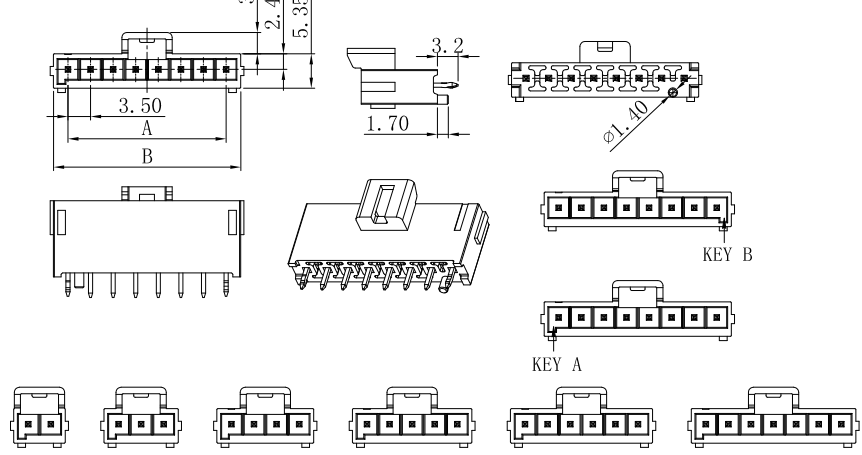
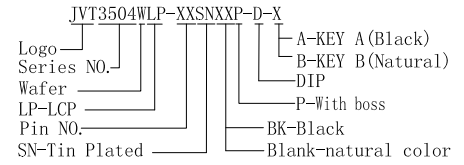
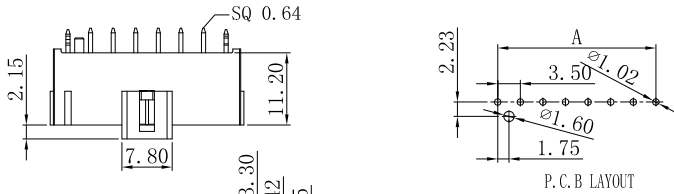

NO.	DIM	
	A	B
02	3.50	8.00
03	7.00	11.50
04	10.50	15.00
05	14.00	18.50
06	17.50	22.00
07	21.00	25.50
08	24.50	29.00

Part No.	Feature	Color
JVT3504WLP-XXSNBKP-D-A	With post KEY A	Black
JVT3504WLP-XXSNP-D-B	With post KEY B	Natural

JVT3504WLP-XXSNXXP-D-X	LCP UL94V-0	Brass	Tin Plated	JVT3503 Housing
PART NO	Material	Material(Pin)	Finish(Pin)	Mates With Part(s)

JVT3504W

3.5mm Pitch 90° Wafer-DIP TYPE

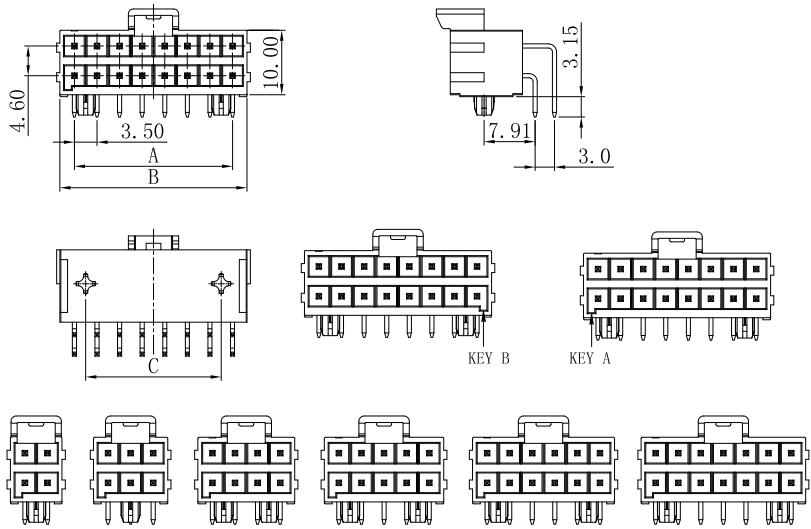
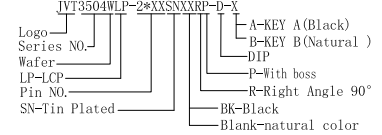
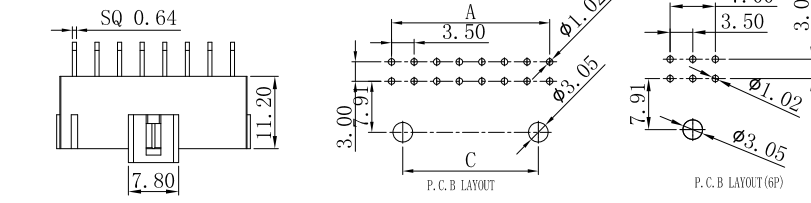

NO.	DIM		
	A	B	C
2*02	3.50	8.00	
2*03	7.00	11.50	
2*04	10.50	15.00	7.00
2*05	14.00	18.50	10.50
2*06	17.50	22.00	14.00
2*07	21.00	25.50	17.50
2*08	24.50	29.00	21.00

Part No.	Feature	Color
JVT3504WLP-2*XXSNBKP-D-A	With post KEY A	Black
JVT3504WLP-2*XXSNP-D-B	With post KEY B	Natural

JVT3504WLP-2*XXSNXXRP-D-X	LCP UL94V-0	Brass	Tin Plated	JVT3503 Housing
PART NO	Material	Material(Pin)	Finish(Pin)	Mates With Part(s)

JVT3503/3504 SERIES 3.5mm pitch wire to board connector

JVT3504W

3.5mm Pitch Wafer-DIP TYPE

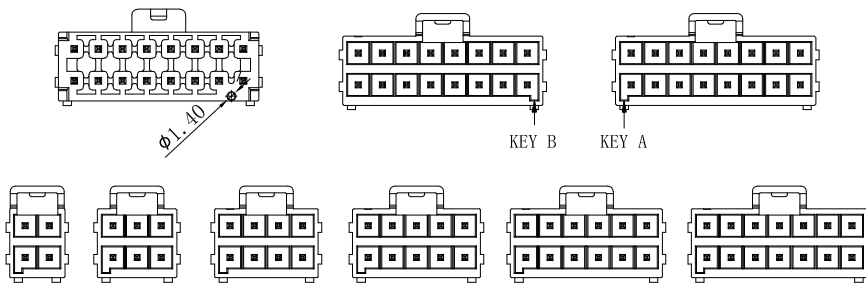
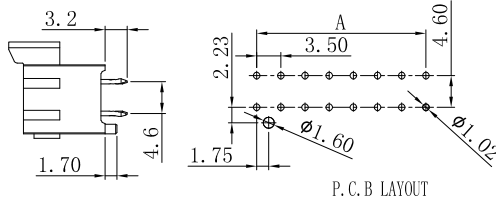
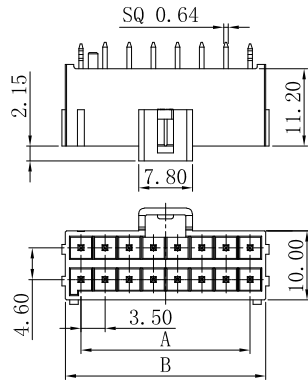

JVT3504WLP-2*XXSNXXP-D-X
 Logo
 Series NO.
 Wafer-
 LP-LCP
 Pin NO.
 SN-Tin Plated
 A-KEY A(Black)
 B-KEY B(Natural)
 DIP
 P-With boss
 BK-Black
 Blank-natural color

NO.	DIM	
	A	B
2*02	3.50	8.00
2*03	7.00	11.50
2*04	10.50	15.00
2*05	14.00	18.50
2*06	17.50	22.00
2*07	21.00	25.50
2*08	24.50	29.00

Part No.	Feature	Color
JVT3504WLP-2*XXSNRP-D-A	With post KEY A	Black
JVT3504WLP-2*XXSNP-D-B	With post KEY B	Natural

JVT3504WLP-2*XXSNXXP-D-X	LCP UL94V-0	Brass	Tin Plated	JVT3503 Housing
PART NO	Material	Material(Pin)	Finish(Pin)	Mates With Part(s)

JVT3504W

3.5mm Pitch 90° Wafer-DIP TYPE

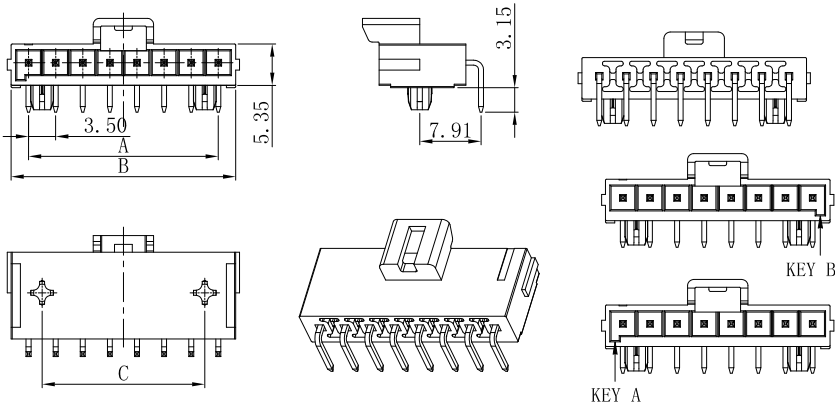
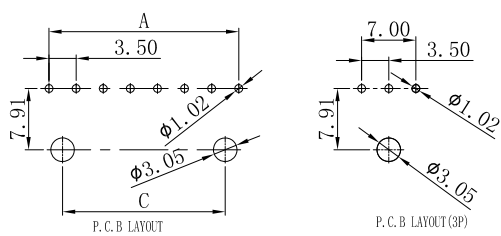
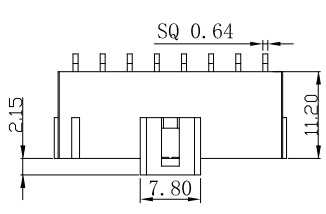

JVT3504WLP-XXSNXXRP-D-X
 Logo
 Series NO.
 Wafer
 LP-LCP
 Pin NO.
 SN-Tin Plated
 A-KEY A(Black)
 B-KEY B(Natural)
 DIP
 P-With boss
 R-Right Angle 90°
 BK-Black
 Blank-natural color

NO.	DIM		
	A	B	C
02	3.50	8.00	
03	7.00	11.50	
04	10.50	15.00	7.00
05	14.00	18.50	10.50
06	17.50	22.00	14.00
07	21.00	25.50	17.50
08	24.50	29.00	21.00

Part No.	Feature	Color
JVT3504WLP-XXSNRP-D-A	With post KEY A	Black
JVT3504WLP-XXSNP-D-B	With post KEY B	Natural

JVT3504WLP-XXSNXXRP-D-X	LCP UL94V-0	Brass	Tin Plated	JVT3503 Housing
PART NO	Material	Material(Pin)	Finish(Pin)	Mates With Part(s)