

Specifications

■ SPECIFICATION

- Voltage rating: 125V AC, DC
- Current Rating: 2A, AC, DC
- Withstand voltage: 500V AC/minute
- Contact resistance: 20mΩ max
- Insulation resistance: 1000MΩ min
- Temperature range: -40°C ~ +105°C
- Suitable JVT2035H series HSG
JVT2065H series HSG
JVT2066H series HSG
JVT2068H series HSG
- Compliant with RoHS and REACH
- Contact JVT for details

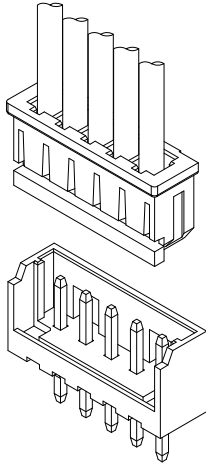

Assembly layout

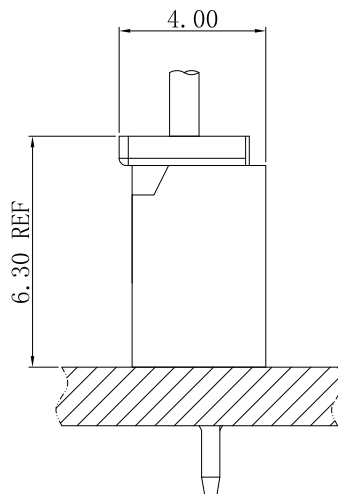

JVT2020/2065 SERIES 2.0mm pitch wire to board connector

JVT2020T

2.0mm Pitch housing

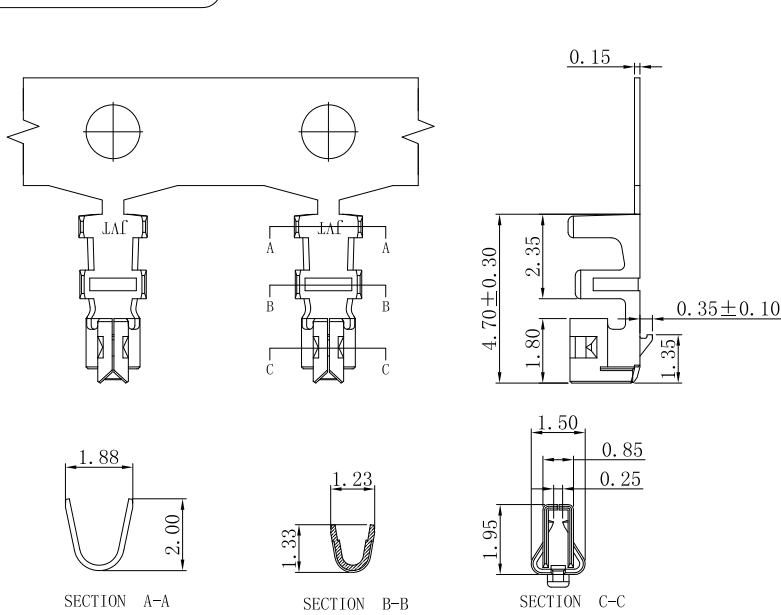

JVT2020TP-SNS
 Logo
 Series NO.
 T-Terminal
 P-Phosphor bronze
 S-Stamping before Plating
 Tin Plated

JVT2020TP-SNS	Phos Bronze	Tin Plated	AWG#24~30	1.4mm(Max)	JVT2035 HOUSING JVT2065 HOUSING JVT2066 HOUSING JVT2068 HOUSING
PART NO	Material	Finish(Pin)	Wire Range	Insulation O.D.	Mates With Part(s)

JVT2020T

2.0mm Pitch Crimp Terminal

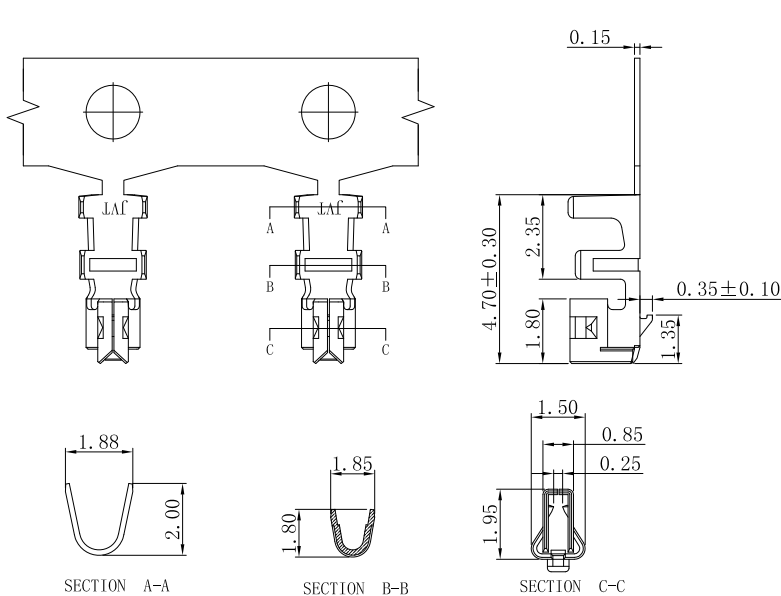

JVT2020TP-SNSH
 Logo
 Series NO.
 T-Terminal
 P-Phosphor bronze
 H-High
 S-Stamping before Plating
 Tin Plated

JVT2020TP-SNSH	Phos Bronze	Tin Plated	AWG#22~26	1.4mm(Max)	JVT2035 HOUSING JVT2065 HOUSING JVT2066 HOUSING JVT2068 HOUSING
PART NO	Material	Finish(Pin)	Wire Range	Insulation O.D.	Mates With Part(s)

JVT2020/2065 SERIES 2.0mm pitch wire to board connector

JVT2065H

2.0mm Pitch housing

HOUSING

Part No. : JVT2065HN0-XXL

Material: PBT, UL94V-0

Mates With Part(s): JVT2020 Terminal

JVT2065HPT-XX

Logo
Series NO.
Housing

Pin NO.
PT-PBT

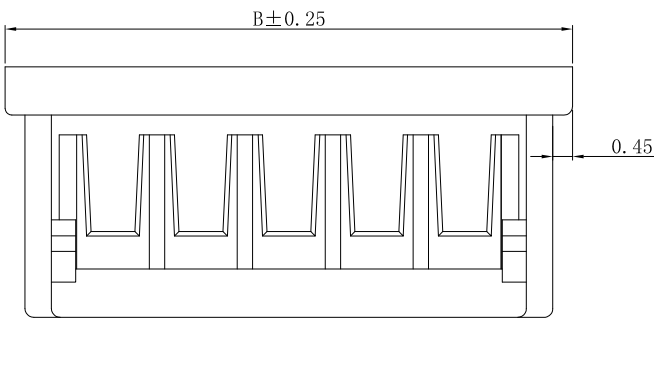
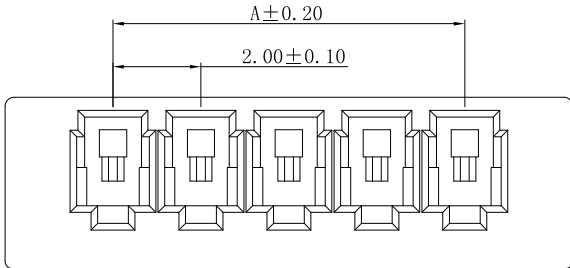

PIN	DIM. (mm)	
	A	B
02	2.00	6.90
03	4.00	8.90
04	6.00	10.90
05	8.00	12.90
06	10.00	14.90
07	12.00	16.90
08	14.00	18.90
09	16.00	20.90
10	18.00	22.90
11	20.00	24.90
12	22.00	26.90
13	24.00	28.90
14	26.00	30.90
15	28.00	32.90

JVT2066H

2.0mm Pitch housing

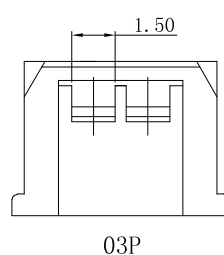
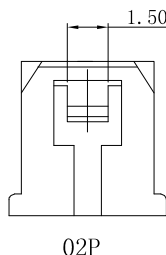
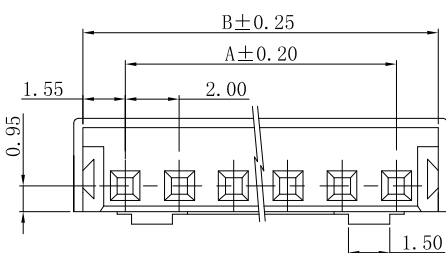
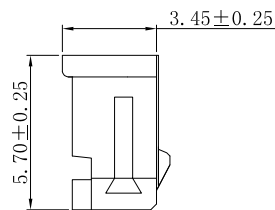
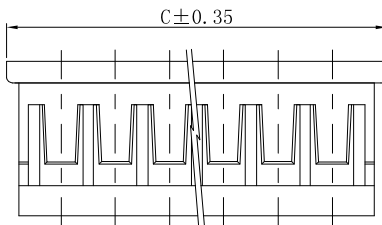
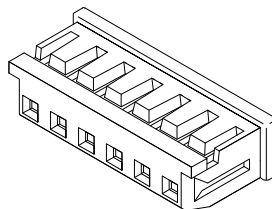
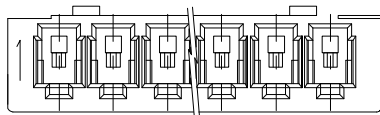

JVT2066HN0-XX

Logo
Series NO.
Housing

Pin NO.
PA66 UL94V-0

PIN	DIM. (mm)		
	A	B	C
02	2.00	5.10	5.80
03	4.00	7.10	7.80
04	6.00	9.10	9.80
05	8.00	11.10	11.80
06	10.00	13.10	13.80
07	12.00	15.10	15.80
08	14.00	17.10	17.80
09	16.00	19.10	19.80
10	18.00	21.10	21.80
11	20.00	23.10	23.80
12	22.00	25.10	25.80
13	24.00	27.10	27.80
14	26.00	29.10	29.80
15	28.00	31.10	31.80

JVT2020/2068 SERIES 2.0mm pitch wire to board connector

JVT2068H

2.0mm Pitch housing

HOUSING

Part No. : JVT2068HPT-XX

Material: PBT, UL94V-0

Mates With Part(s): JVT2020 Terminal

JVT2068HPT-XX

Logo
Series NO.
Housing

Pin NO.
PT-PBT

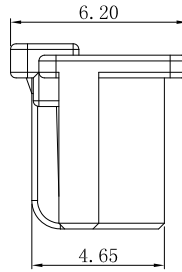
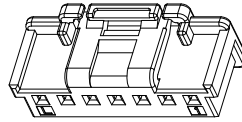
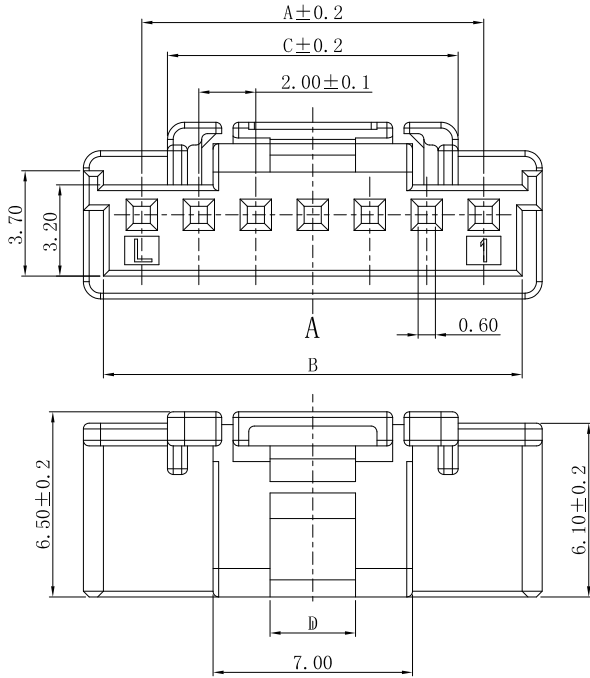

Poles	Dimensions (mm)		Poles	Dimensions (mm)	
	A	B		C	D
02	2.00	4.70	02	8.00	2.00
03	4.00	6.70	03	8.10	2.20
04	6.00	8.70	04	10.10	3.00
05	8.00	10.70	05	10.20	
06	10.00	12.70	06		
07	12.00	14.70	07		
08	14.00	16.70	08		
09	16.00	18.70	09		
10	18.00	20.70	10		
11	20.00	22.70	11		
12	22.00	24.70	12		
13	24.00	26.70	13		
14	26.00	28.70	14		
15	28.00	30.70	15		

JVT2020/2065 SERIES 2.0mm pitch wire to board connector

JVT2065W

2.0mm Pitch housing

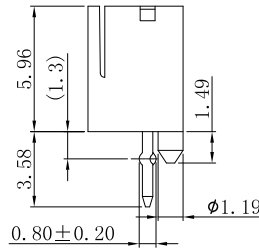
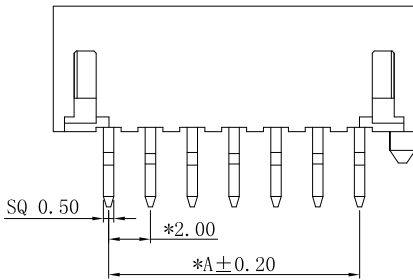
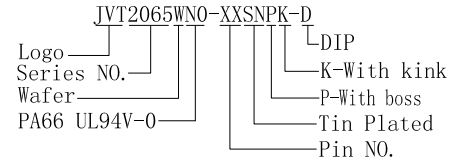
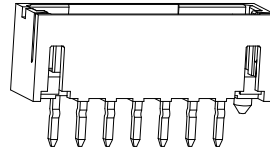
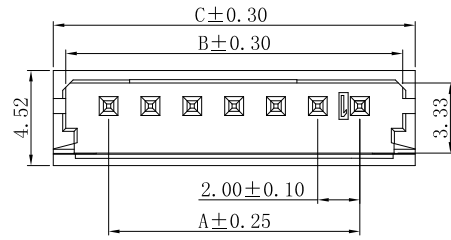

PIN	DIM. (mm)		
	A	B	C
02	2.00	6.10	7.30
03	4.00	8.10	9.30
04	6.00	10.10	11.30
05	8.00	12.10	13.30
06	10.00	14.10	15.30
07	12.00	16.10	17.30
08	14.00	18.10	19.30
09	16.00	20.10	21.30
10	18.00	22.10	23.30
11	20.00	24.10	25.30
12	22.00	26.10	27.30
13	24.00	28.10	29.30
14	26.00	30.10	31.30
15	28.00	32.10	33.30

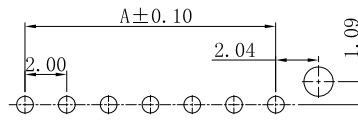
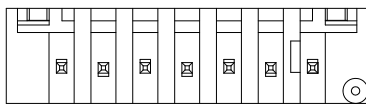

P. C. B LAYOUT

JVT2065WN0-XXSNPK-D	PA66 UL94V-0	Brass	Tin Plated	JVT2065 Housing
PART NO	Material	Material(Pin)	Finish(Pin)	Mates With Part(s)

JVT2065W

2.0mm Pitch housing

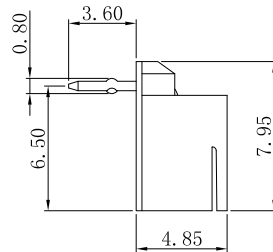
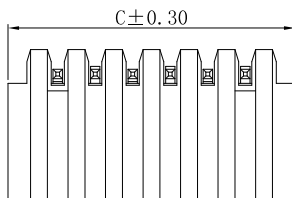
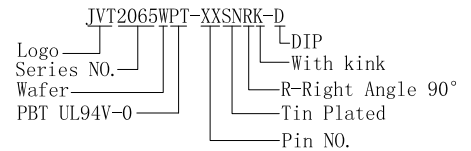
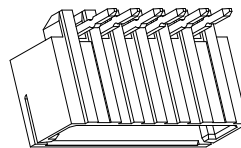
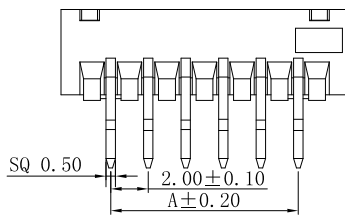

PIN	DIM. (mm)		
	A	B	C
02	2.00	6.10	7.30
03	4.00	8.10	9.30
04	6.00	10.10	11.30
05	8.00	12.10	13.30
06	10.00	14.10	15.30
07	12.00	16.10	17.30
08	14.00	18.10	19.30
09	16.00	20.10	21.30
10	18.00	22.10	23.30
11	20.00	24.10	25.30
12	22.00	26.10	27.30
13	24.00	28.10	29.30
14	26.00	30.10	31.30
15	28.00	32.10	33.30

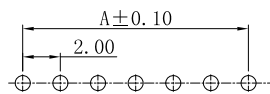
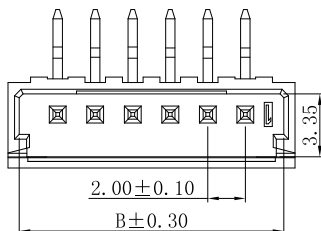

P. C. B LAYOUT

JVT2065WPT-XXSNRK-D	PBT UL94V-0	Brass	Tin Plated	JVT2065 Housing
PART NO	Material	Material(Pin)	Finish(Pin)	Mates With Part(s)

JVT2020/2066 SERIES 2.0mm pitch wire to board connector

JVT2066W

2.0mm Pitch Wafer-DIP TYPE

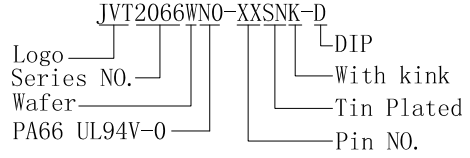
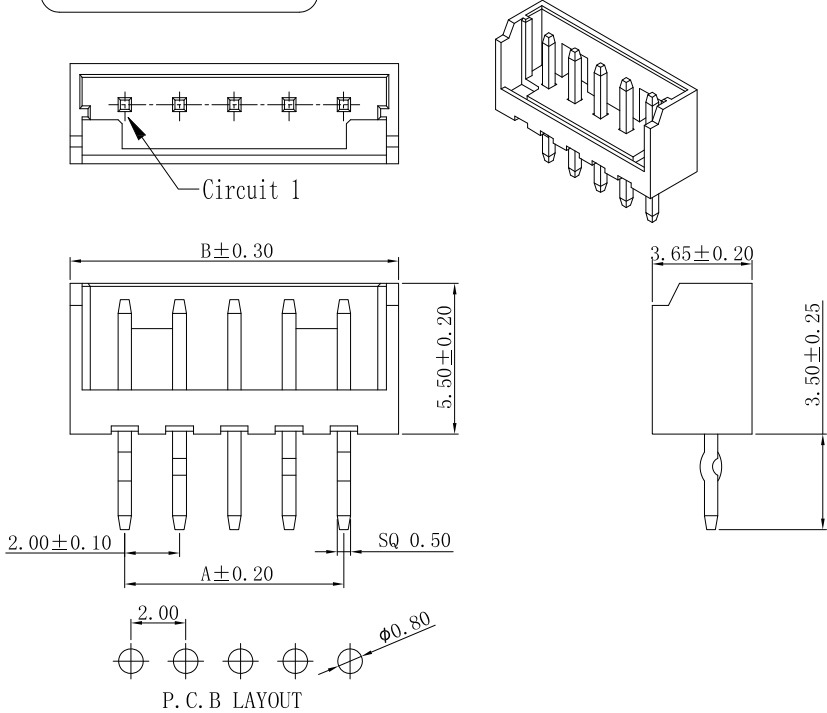

PIN	DIM. (mm)	
	A	B
02	2.00	6.00
03	4.00	8.00
04	6.00	10.00
05	8.00	12.00
06	10.00	14.00
07	12.00	16.00
08	14.00	18.00
09	16.00	20.00
10	18.00	22.00
11	20.00	24.00
12	22.00	26.00
13	24.00	28.00
14	26.00	30.00
15	28.00	32.00

JVT2066WNO-XXSNK-D	PA66 UL94V-0	Brass	Tin Plated	JVT2066 Housing
PART NO	Material	Material(Pin)	Finish(Pin)	Mates With Part(s)

JVT2066W

2.0mm Pitch 90° Wafer-DIP TYPE

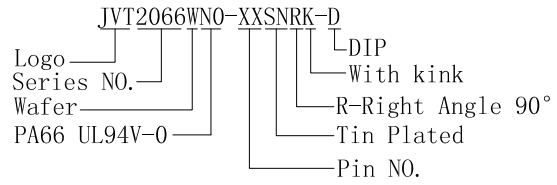
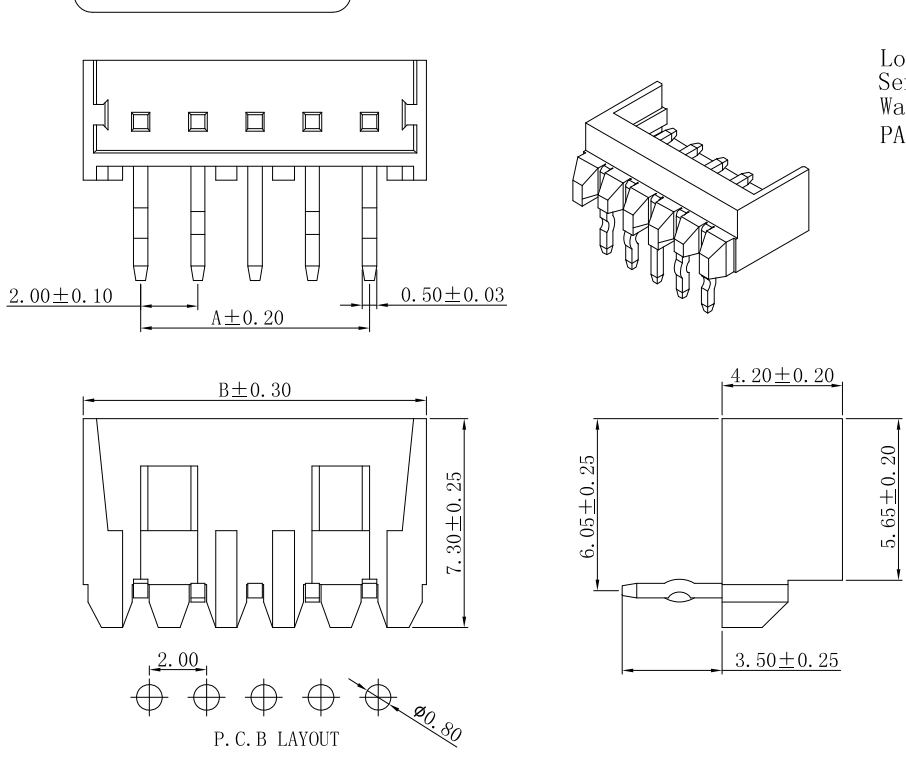

PIN	DIM. (mm)	
	A	B
02	2.00	6.00
03	4.00	8.00
04	6.00	10.00
05	8.00	12.00
06	10.00	14.00
07	12.00	16.00
08	14.00	18.00
09	16.00	20.00
10	18.00	22.00
11	20.00	24.00
12	22.00	26.00
13	24.00	28.00
14	26.00	30.00
15	28.00	32.00

JVT2066WNO-XXSNRK-D	PA66 UL94V-0	Brass	Tin Plated	JVT2066 Housing
PART NO	Material	Material(Pin)	Finish(Pin)	Mates With Part(s)

JVT2020/2068 SERIES 2.0mm pitch wire to board connector

JVT2068W

2.0mm Pitch Wafer-DIP TYPE

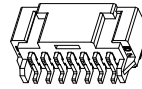
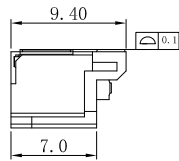
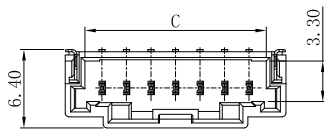

JVT2068W9T-XXSNR-S
Logo
Series NO.
Wafer
9T-PA9T
SMT
R-Right Angle 90°
Tin Plated
Pin NO.

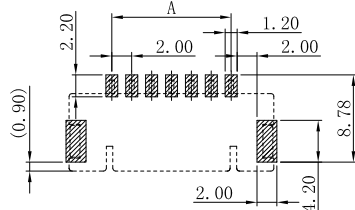
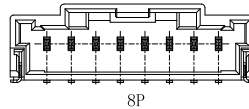
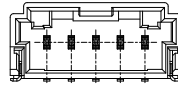
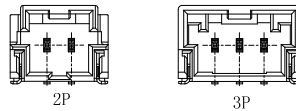
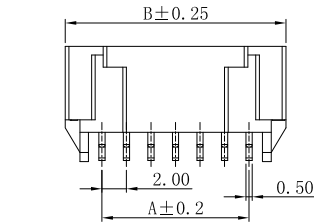

Circuits	Dimensions		
	DIM A	DIM B	DIM C
02	2.00	10.60	4.80
03	4.00	12.60	6.80
04	6.00	14.60	8.80
05	8.00	16.60	10.80
06	10.00	18.60	12.80
07	12.00	20.60	14.80
08	14.00	22.60	16.80
09	16.00	24.60	18.80
10	18.00	26.60	20.80
11	20.00	28.60	22.80
12	22.00	30.60	24.80
13	24.00	32.60	26.80
14	26.00	34.60	28.80
15	28.00	36.60	30.80

JVT2068W9T-XXSNR-S	PA9T UL94V-0	Brass	Tin Plated	JVT2068 Housing
PART NO	Material	Material(Pin)	Finish(Pin)	Mates With Part(s)

JVT2068W

2.0mm Pitch 90° Wafer-DIP TYPE

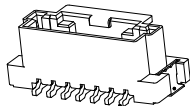
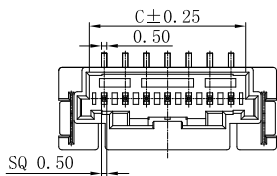

JVT2068W9T-XXSN-S
Logo
Series NO.
Wafer
9T-PA9T
SMT
Tin Plated
Pin NO.

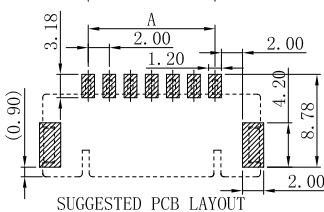
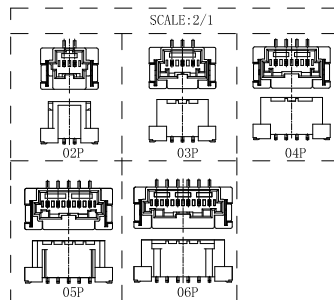
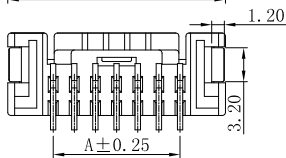
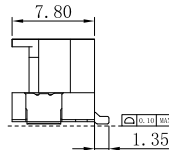
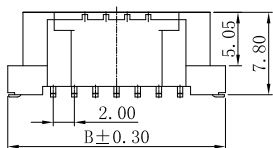

Circuits	Dimensions		
	DIM A	DIM B	DIM C
02	2.00	10.60	4.80
03	4.00	12.60	6.80
04	6.00	14.60	8.80
05	8.00	16.60	10.80
06	10.00	18.60	12.80
07	12.00	20.60	14.80
08	14.00	22.60	16.80
09	16.00	24.60	18.80
10	18.00	26.60	20.80
11	20.00	28.60	22.80
12	22.00	30.60	24.80
13	24.00	32.60	26.80
14	26.00	34.60	28.80
15	28.00	36.60	30.80

JVT2068W9T-XXSN-S	PA9T UL94V-0	Brass	Tin Plated	JVT2068 Housing
PART NO	Material	Material(Pin)	Finish(Pin)	Mates With Part(s)