

Specifications

- Voltage rating: 150V AC, DC
- Current Rating: 1A, AC, DC
- Withstand voltage: 500V AC/minute
- Contact resistance: 30mΩ max
- Insulation resistance: 500MΩ min
- Temperature range: -40°C ~ +105°C
- Compliant with RoHS and REACH
- Contact JVT for details

Assembly layout

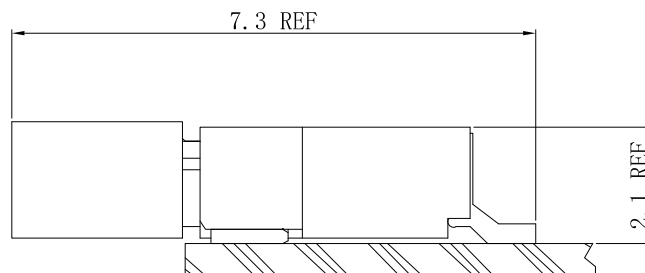

JVT1247 SERIES

1.25mm pitch wire to board connector

JVT1247H

1.25mm Pitch housing

HOUSING

Part No. : JVT1247HNO-XXBK

Material: PA66 UL94V-0

Mates With Part(s): JVT1247 Terminal

JVT1247HNO-XXBK
Logo Series NO. Housing Black Pin NO. PA66 UL94V-0

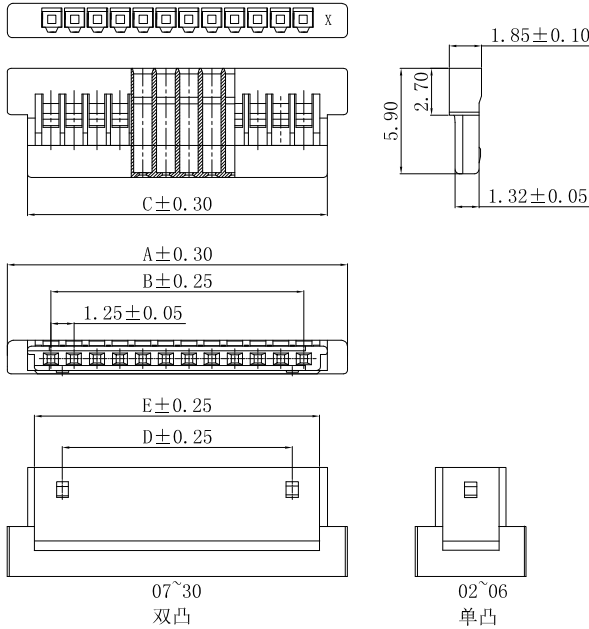

Poles	Dimensions (mm)				
	A	B	C	D	E
02	6.00	1.25	3.80	---	3.20
03	7.25	2.50	5.05	---	4.45
04	8.50	3.75	6.30	---	5.70
05	9.75	5.00	7.55	---	6.95
06	11.00	6.25	8.80	---	8.20
08	13.50	8.75	11.30	7.70	10.70
10	16.00	11.25	13.80	10.20	13.20
15	22.25	17.50	20.05	16.45	19.45
20	28.50	23.75	26.30	22.70	25.70
25	34.75	30.00	32.55	28.95	31.95
30	41.00	36.25	38.80	35.20	38.20

Unit:mm

JVT1247T

1.25mm Pitch Crimp Terminal

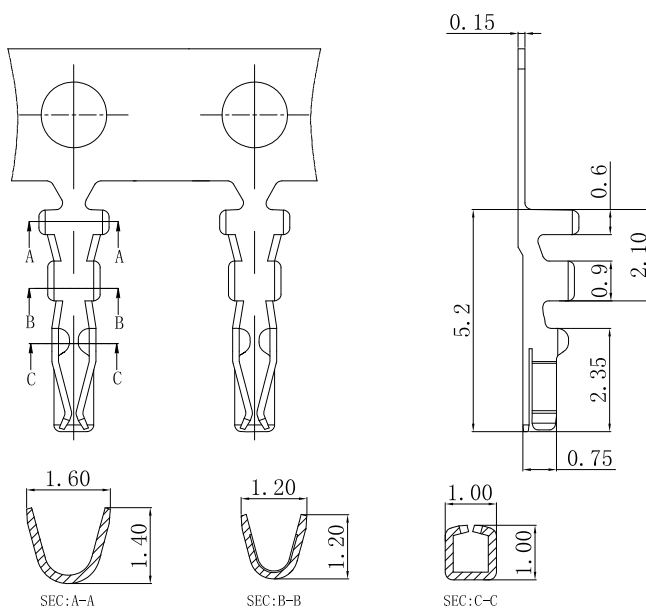

JVT1247TP-XXXX
Logo Series NO. T-Terminal P-Phosphor bronze S-Stamping before Plating E-Plating before stamping SN-Tin Plated GA-All gold plating GP-Gold plating

JVT1247TP-GPXA	Phos Bronze	Half Gold	AWG#28~32	0.8mm(Max)	JVT1247 HOUSING
JVT1247TP-GAXA		Gold Plated			
JVT1247TP-SNXA		Tin Plated			
PART NO	Material	Finish(Pin)	Wire Range	Insulation O.D.	Mates With Part(s)

JVT1247 SERIES

1.25mm pitch wire to board connector

JVT1247W

1.25mm Pitch 90° Wafer-SMT TYPE

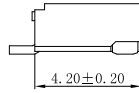
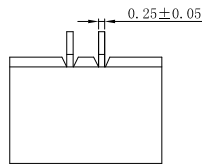

JVT1247WLP-XXXXR-S
 Logo
 Series NO.
 Wafer
 LP-LCP
 SMT
 R-Right Angle 90°
 GA-All gold plating
 SN-Tin Plated
 Pin NO.

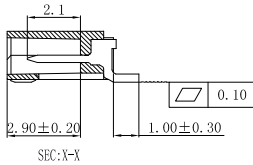
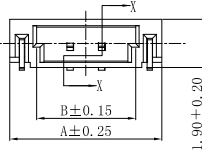

Poles	Dimensions (mm)		
	A	B	C
02	6.00	3.90	1.25
03	7.25	5.15	2.50
04	8.50	6.40	3.75
05	9.75	7.65	5.00
06	11.00	8.90	6.25
08	13.50	11.40	8.75
09	14.75	12.65	10.00
10	16.00	13.90	11.25
11	17.25	15.15	12.50
12	18.50	16.40	13.75
13	19.75	17.65	15.00
14	21.00	18.90	16.25
15	22.25	20.15	17.50

Unit:mm

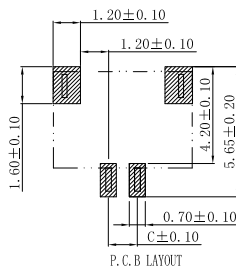
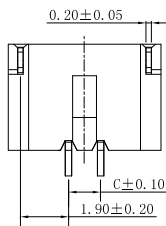

JVT1247WLP-XXGAR-S	LCP UL94V-0	Brass	Gold plated	JVT1247 Housing
JVT1247WLP-XXSNR-S			Tin Plated	
PART NO	Material	Material(Pin)	Finish(Pin)	Mates With Part(s)