

## Specifications

- Voltage rating: 250V AC, DC
- Current Rating: 3A, AC, DC
- Withstand voltage: 1000V AC/minute
- Contact resistance: 20mΩ max
- Insulation resistance: 1000MΩ min
- Temperature range: -40°C ~ +105°C
- \*Suitable JVT2513T series Terminal  
JVT2513W series Wafer
- Compliant with RoHS and REACH  
Contact JVT for details

## Assembly layout

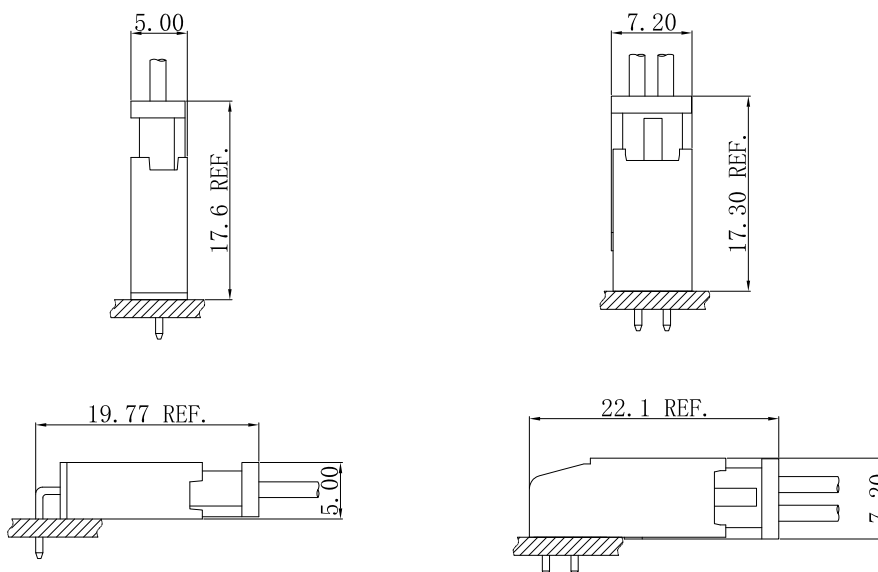

**JVT2513H**

2.5mm Pitch housing

HOUSING

Part No.: JVT2513HPT-XXBK  
Material: PBT UL 94V-0(Black)  
Mates With Part(s): JVT2513 Terminal

JVT2513HPT-XXBK  
Logo  
Series NO.  
Housing  
PT-PBT  
BK-Black  
Pin NO.

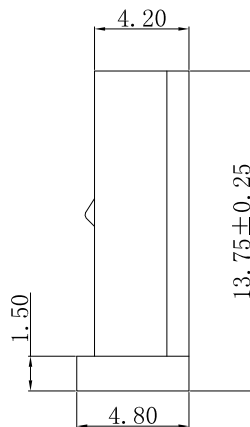
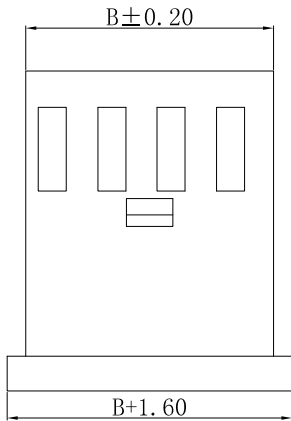
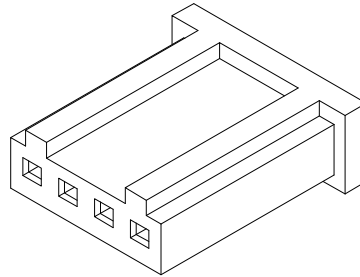
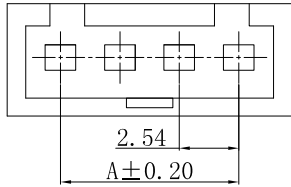

Poles	Dimensions (mm)		Poles	Dimensions (mm)	
	A	B		A	B
02P	2.54	5.60	13P	30.48	33.54
03P	5.08	8.14	14P	32.02	36.08
04P	7.62	10.68	15P	35.56	38.62
05P	10.16	13.22	16P	38.10	41.16
06P	12.70	15.76	17P	40.64	43.70
07P	15.24	18.30	18P	43.18	46.24
08P	17.78	20.84	19P	45.72	48.78
09P	20.32	23.38	20P	48.26	51.32
10P	22.86	25.92	21P	50.80	53.86
11P	25.40	28.46	22P	53.34	56.40
12P	27.94	31.00			

**JVT2508T**

2.5mm Pitch Crimp Terminal

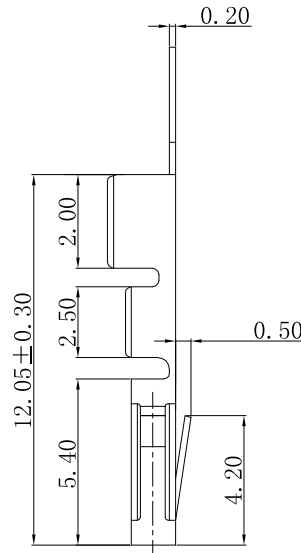
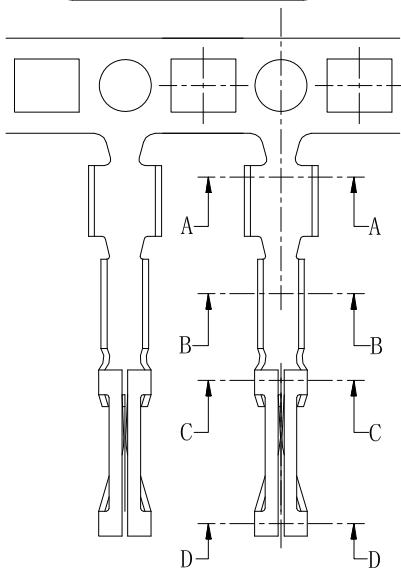

JVT2513TP-XXS  
Logo  
Series NO.  
T-Terminal  
P-Phosphor bronze  
S-Stamping before Plating  
SN-Tin Plated  
GP-Gold plating

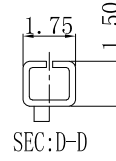
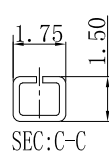
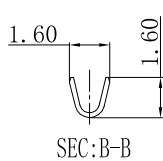
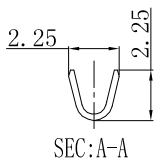

JVT2513TP-GPS	Phos Bronze	Gold plating	AWG#22~26	1.55mm(Max)	JVT2513 HOUSING
JVT2513TP-SNS		Tin Plated			
PART NO	Material	Finish(Pin)	Wire Range	Insulation O.D.	Mates With Part(s)

**JVT2513W**

2.5mm Pitch Wafer-DIP TYPE

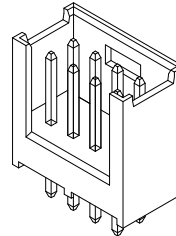
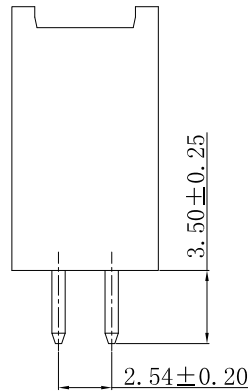
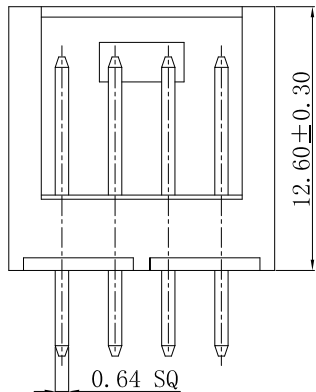
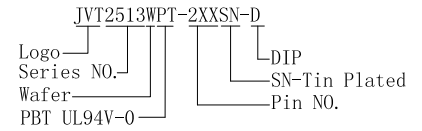
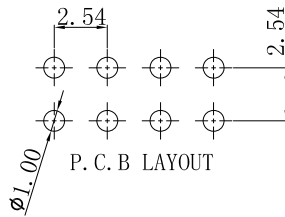
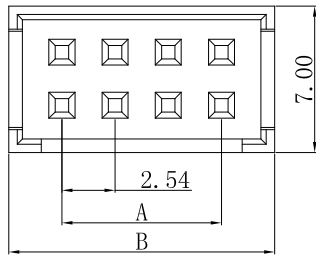

Poles	Dimensions (mm)		Poles	Dimensions (mm)	
	A	B		A	B
02	2.54	7.46	18	43.18	48.10
03	5.08	10.00	19	45.72	50.64
04	7.62	12.54	20	48.26	53.18
05	10.16	15.08	21	50.80	55.72
06	12.70	17.62	22	53.34	58.26
07	15.24	20.16	23	55.88	60.80
08	17.78	22.70	24	58.42	63.34
09	20.32	25.24	25	60.96	65.88
10	22.86	27.78	26	63.50	68.42
11	25.40	30.32	27	66.04	70.96
12	27.94	32.86	28	68.58	73.50
13	30.48	35.40	29	71.12	76.04
14	33.02	37.94	30	73.66	78.58
15	35.56	40.48	31	76.20	81.12
16	38.10	43.02	32	78.74	83.66
17	40.64	45.56			

JVT2513WPT-2XXSN-D	PBT UL94V-0	Brass	Tin Plated	JVT2513 Housing
PART NO	Material	Material(Pin)	Finish(Pin)	Mates With Part(s)

**JVT2513W**

2.5mm Pitch 90°Wafer-DIP TYPE

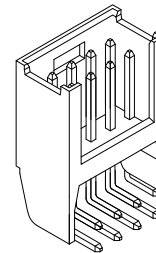
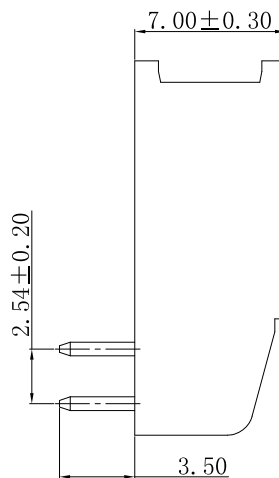
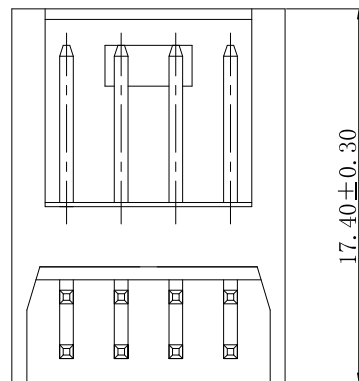
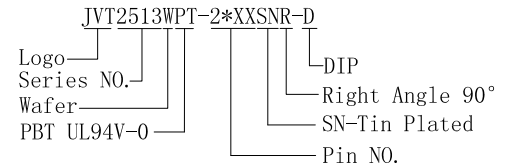
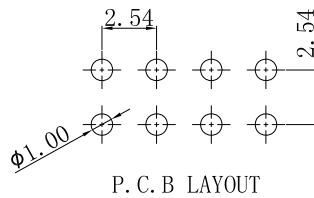
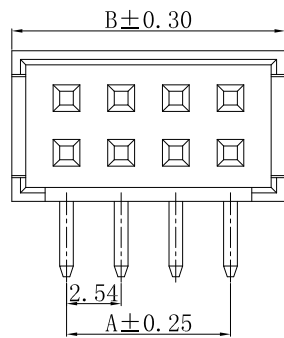

Poles	Dimensions (mm)		Poles	Dimensions (mm)	
	A	B		A	B
02	2.54	7.46	18	43.18	48.10
03	5.08	10.00	19	45.72	50.64
04	7.62	12.54	20	48.26	53.18
05	10.16	15.08	21	50.80	55.72
06	12.70	17.62	22	53.34	58.26
07	15.24	20.16	23	55.88	60.80
08	17.78	22.70	24	58.42	63.34
09	20.32	25.24	25	60.96	65.88
10	22.86	27.78	26	63.50	68.42
11	25.40	30.32	27	66.04	70.96
12	27.94	32.86	28	68.58	73.50
13	30.48	35.40	29	71.12	76.04
14	33.02	37.94	30	73.66	78.58
15	35.56	40.48	31	76.20	81.12
16	38.10	43.02	32	78.74	83.66
17	40.64	45.56			

JVT2513WPT-2*XXSNR-D	PBT UL94V-0	Brass	Tin Plated	JVT2513 Housing
PART NO	Material	Material(Pin)	Finish(Pin)	Mates With Part(s)

**JVT2513W** — 2.54mm Pitch Wafer-DIP TYPE

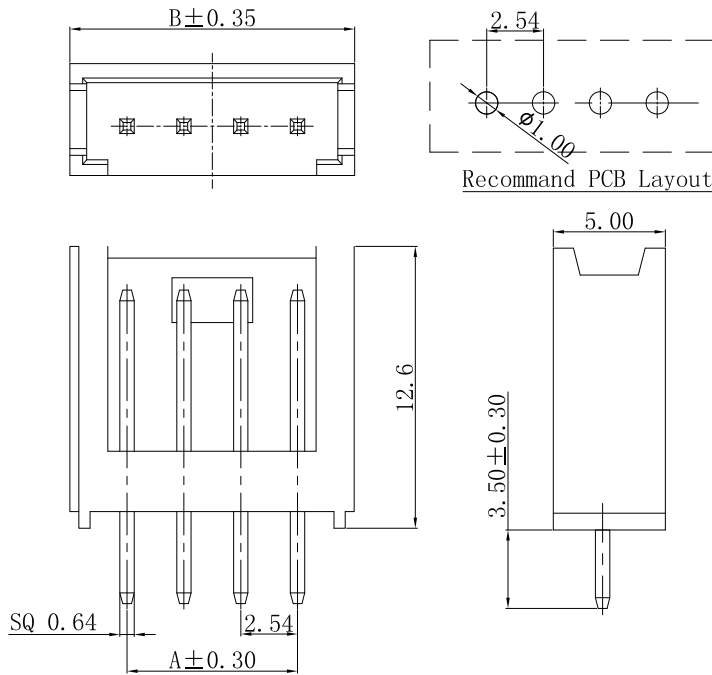

JVT2513WPT-XXSN-D  
Logo  
Series NO.  
Wafer  
PBT UL94V-0  
DIP  
SN-Tin Plated  
Pin NO.

Poles	Dimensions (mm)		Poles	Dimensions (mm)	
	A	B		A	B
02	2.54	7.62	13P	30.48	35.56
03	5.08	10.16	14P	33.02	38.10
04	7.62	12.70	15P	35.56	40.64
05	10.16	15.24	16P	38.10	43.18
06	12.70	17.78	17P	40.64	45.72
07	15.24	20.32	18P	43.18	48.26
08	17.78	22.86	19P	45.72	50.80
09	20.32	25.40	20P	48.26	53.34
10	22.86	27.94	21P	50.80	55.88
11	25.40	30.48	22P	53.34	58.42
12	27.94	33.02			

JVT2513WPT-XXSN-D	PBT UL94V-0	Brass	Tin Plated	JVT2513 Housing
PART NO	Material	Material(Pin)	Finish(Pin)	Mates With Part(s)

**JVT2513W** — 2.54mm Pitch 90° Wafer-DIP TYPE

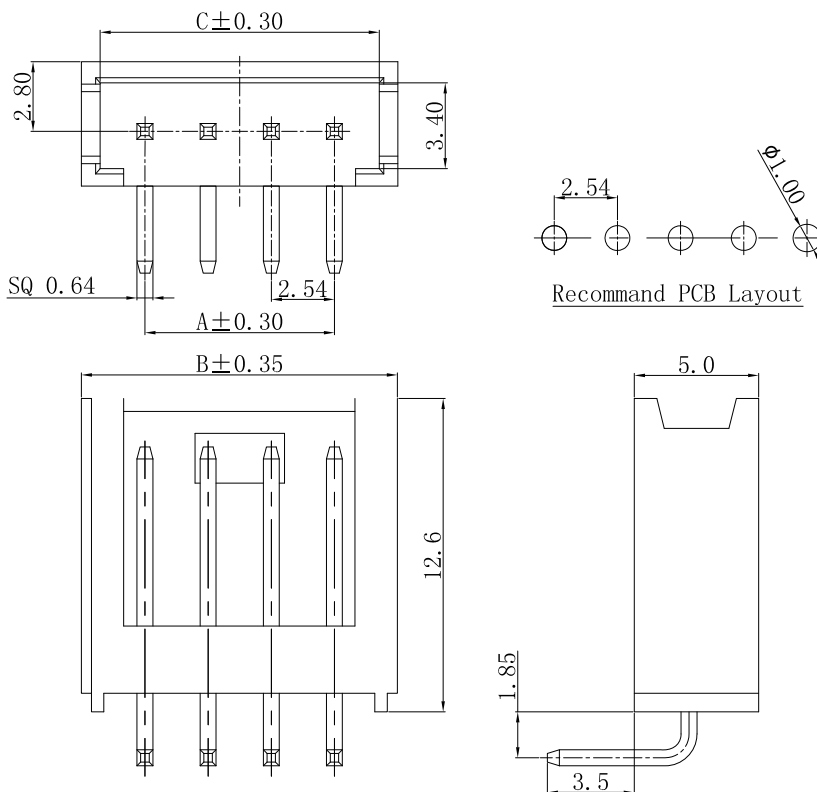

JVT2513WPT-XXSNR-D  
Logo  
Series NO.  
Wafer  
PBT UL94V-0  
DIP  
Right Angle 90°  
SN-Tin Plated  
Pin NO.

Poles	Dimensions (mm)		
	A	B	C
02	2.54	7.62	6.22
03	5.08	10.16	8.76
04	7.62	12.70	11.30
05	10.16	15.24	13.84
06	12.70	17.78	16.38
07	15.24	20.32	18.92
08	17.78	22.86	21.46
09	20.32	25.40	24.00
10	22.86	27.94	26.54
11	25.40	30.48	29.08
12	27.94	33.02	31.62
13	30.48	35.56	34.16
14	33.02	38.10	36.70
15	35.56	40.64	39.24
16	38.10	43.18	41.78
17	40.64	45.72	44.32
18	43.18	48.26	46.86
19	45.72	50.80	49.40
20	48.26	53.34	51.94

JVT2513WPT-XXSNR-D	PBT UL94V-0	Brass	Tin Plated	JVT2513 Housing
PART NO	Material	Material(Pin)	Finish(Pin)	Mates With Part(s)