

Specifications

- Voltage rating: 250V AC, DC
- Current Rating: 6A, AC, DC
- Withstand voltage: 1000V AC/minute
- Contact resistance: 20mΩ max
- Insulation resistance: 1000mΩ min
- Temperature range: -40°C ~ +105°C
- Compliant with RoHS and REACH
- Contact JVT for details

Assembly layout

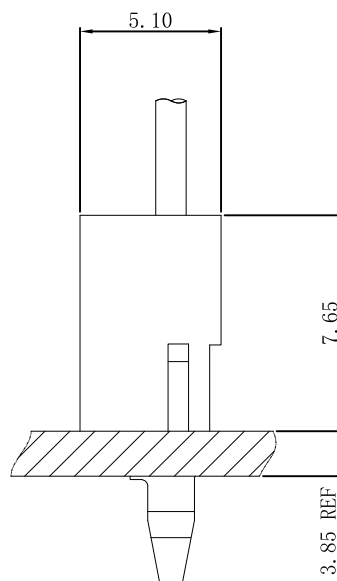

JVT4008H

3.96mm Pitch housing

HOUSING

Part No.: JVT4008HNO-XX

Material: Nylon 66 UL94V-0

Mates With Part(s): JVT4008 Terminal

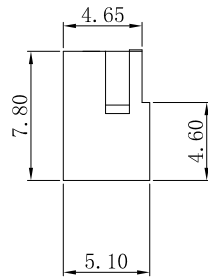
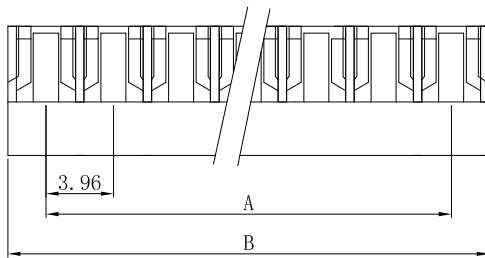
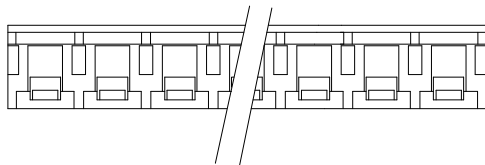
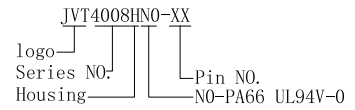

PRATNO	A	B
02	3.96	8.42
03	7.92	12.38
04	11.88	16.34
05	15.84	20.30
06	19.80	24.26
07	23.76	28.22
08	27.72	32.18
09	31.68	36.14
10	35.64	40.10
11	39.60	44.06
12	43.56	48.02
13	47.52	51.98
14	51.48	55.94
15	55.44	59.90

JVT4008T

3.96mm Pitch Crimp Terminal

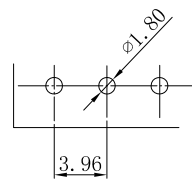
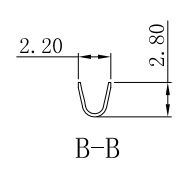
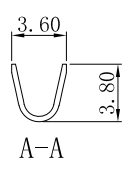
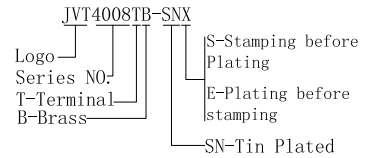
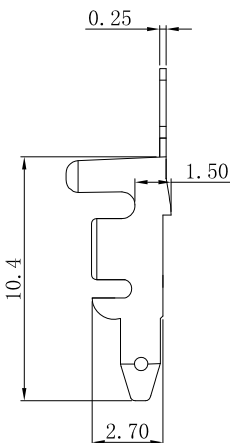
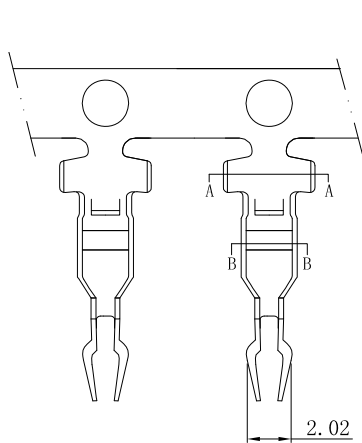

PCB LAYOUT

JVT4008TB-SNX	Brass	Tin Plated	AWG#22~18	3.0mm (Max)	JVT4008 HOUSING
PART NO	Material	Finish(Pin)	Wire Range	Insulation O.D.	Mates With Part(s)