

Specifications

- Voltage rating: 150V AC, DC
- Current Rating: 1A, AC, DC
- Withstand voltage: 500V AC/minute
- Contact resistance: 30mΩ max
- Insulation resistance: 500mΩ min
- Temperature range: -40°C ~ +105°C
- Compliant with RoHS and REACH
- Contact JVT for details

Assembly layout

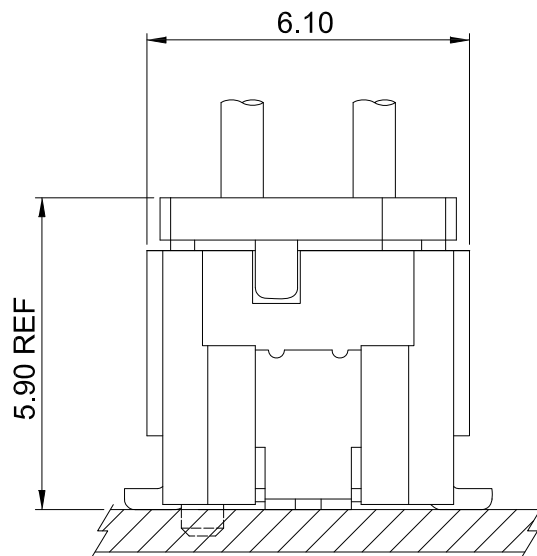

JVT1255/1256 SERIES

1.25mm pitch wire to board connector

JVT1255H

1.25mm Pitch housing

HOUSING

Part No. : JVT1255HNO-XX

Material: Nylon 66 UL94V-0

Mates With Part(s): JVT1255 Terminal

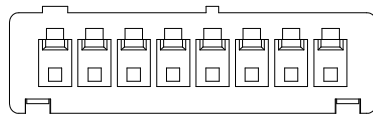
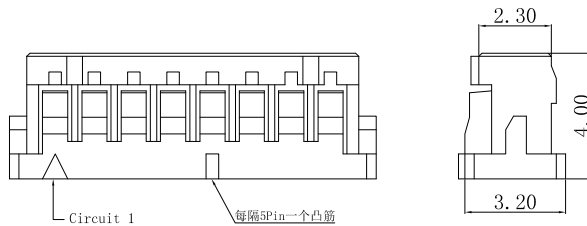
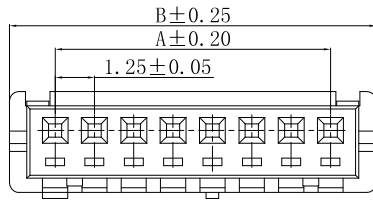
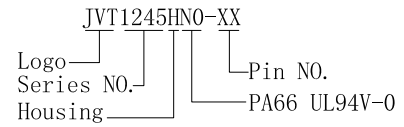

Poles	Dimensions (mm)	
	A	B
02	1.25	4.15
03	2.50	5.40
04	3.75	6.65
05	5.00	7.90
06	6.25	9.15
07	7.50	10.40
08	8.75	11.65
09	10.00	12.90
10	11.25	14.15
11	12.50	15.40
12	13.75	16.65
13	15.00	17.90
14	16.25	19.15
15	17.50	20.40

Unit:mm

JVT1255H

1.25mm Pitch housing

HOUSING

Part No. : JVT1255HNO-2*XX

Material: Nylon 66 UL94V-0

Mates With Part(s): JVT1255 Terminal

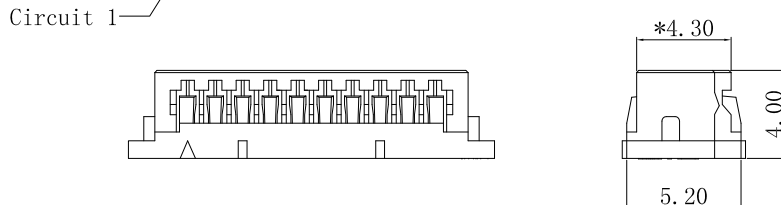
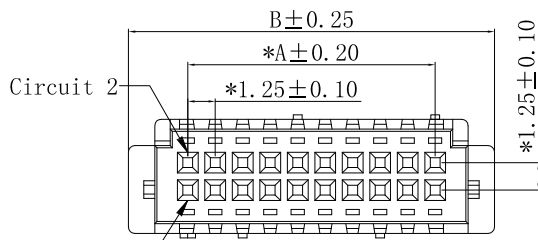
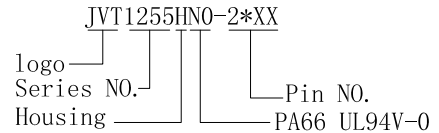

Poles	Dimensions (mm)	
	A	B
2*05	5.00	10.40
2*06	6.25	11.65
2*07	7.50	12.90
2*10	11.25	16.65
2*15	17.50	22.90
2*17	20.00	25.40
2*18	21.25	26.65
2*20	23.75	29.15
2*21	25.00	30.40
2*25	30.00	35.40

Unit:mm

JVT1255/1256 SERIES

1.25mm pitch wire to board connector

JVT1255H

1.25mm Pitch housing

HOUSING

Part No. : JVT1255HNO-2*XXL

Material: Nylon 66 UL94V-0

Mates With Part(s): JVT1255 Terminal

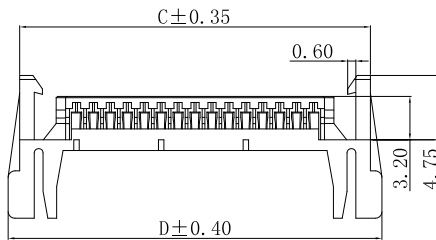
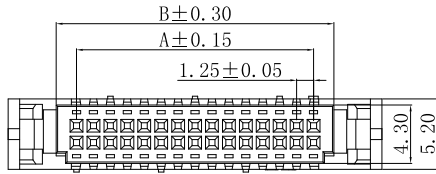
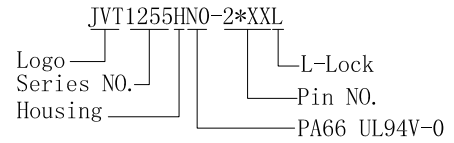

Poles	Dimensions (mm)			
	A	B	C	D
2*05	5.00	8.00	13.40	15.10
2*06	6.25	9.25	14.65	16.35
2*07	7.50	10.50	15.90	17.30
2*10	11.25	14.25	19.65	21.35
2*15	17.50	20.50	25.90	27.60
2*20	23.75	26.75	32.15	33.85

Unit:mm

Note:

2*05pin配套: JVT1245TP-XXXFB
 ≥2*05pin配套: JVT1245TP-XXXFS

JVT1255T

1.25mm Pitch Crimp Terminal

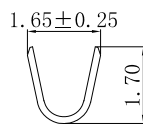
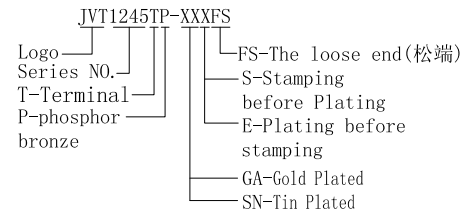
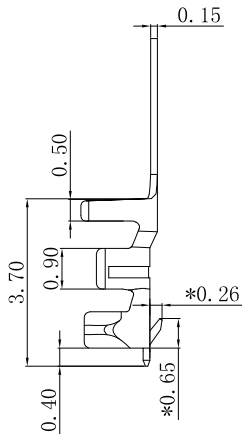
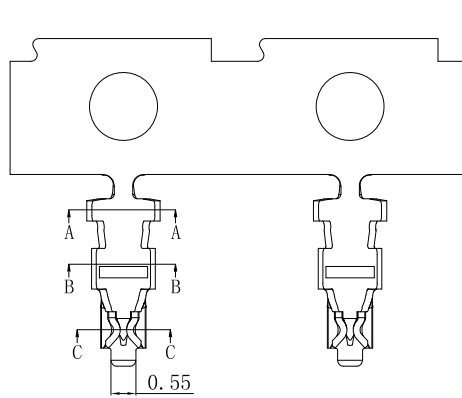

SEC:A-A

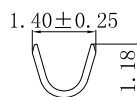

SEC:B-B

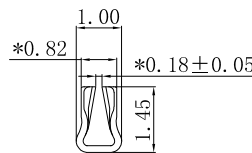

SEC:C-C

JVT1255TP-GAXFS	Phos Bronze	Gold Plated	AWG#26~30	1.0mm(Max)	JVT1255 HOUSING
JVT1255TP-SNXFS		Tin Plated			
PART NO	Material	Finish(Pin)	Wire Range	Insulation O.D.	Mates With Part(s)

JVT1255/1256 SERIES 1.25mm pitch wire to board connector

JVT1255T — 1.25mm Pitch Crimp Terminal

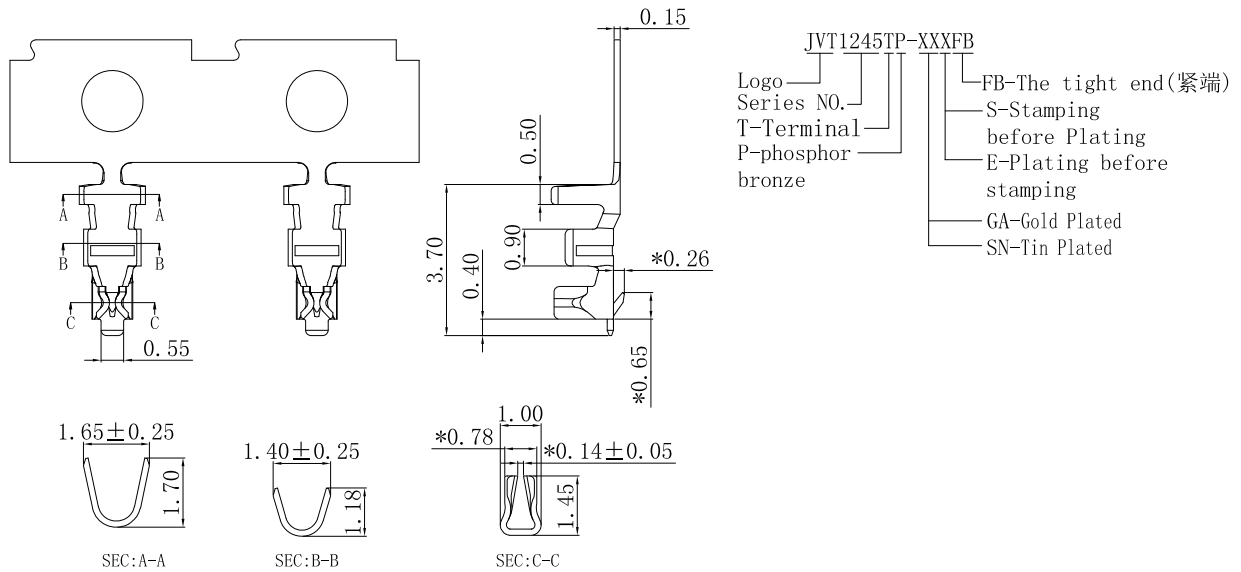

JVT1255TP-GAXFB	Phos Bronze	Gold Plated	AWG#26~30	1.0mm(Max)	JVT1255 HOUSING
JVT1255TP-SNXFB		Tin Plated			
PART NO	Material	Finish(Pin)	Wire Range	Insulation O.D.	Mates With Part(s)

JVT1256W — 1.25mm Pitch Wafer-SMT TYPE

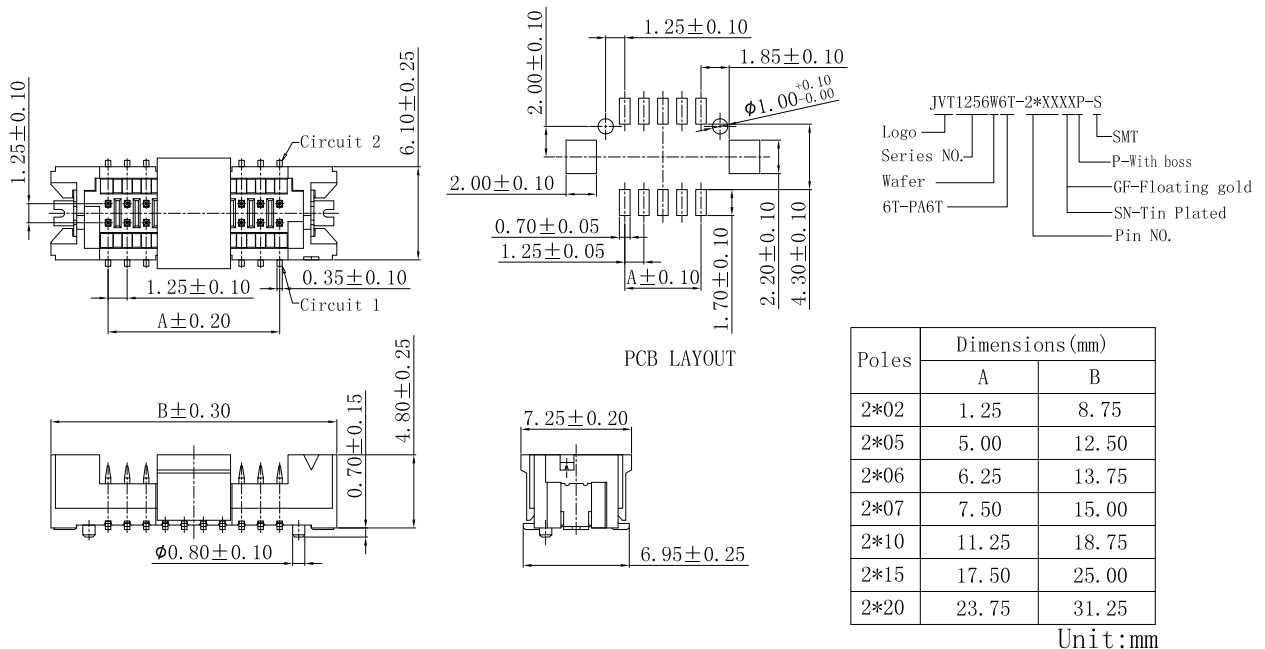

JVT1256W6T-2*XXGFP-S	PA6T UL94V-0	Brass	Half Gold	Brass	JVT1255 Housing
JVT1256WLP-2*XXSNP-S	LCP UL94V-0		Tin Plated		
PART NO	Material	Material(Pin)	Finish(Pin)	Material (Solder Tabs)	Mates With Part(s)