

JVT3502 SERIES

3.5mm pitch wire to board connector

Specifications

- Voltage rating: 250V AC, DC
- Current Rating: 5.5A, AC, DC
- Withstand voltage: 1500V AC/minute
- Contact resistance: 10mΩ max
- Insulation resistance: 1000mΩ min
- Temperature range: -40°C ~ +105°C
- Compliant with RoHS and REACH
- Contact JVT for details

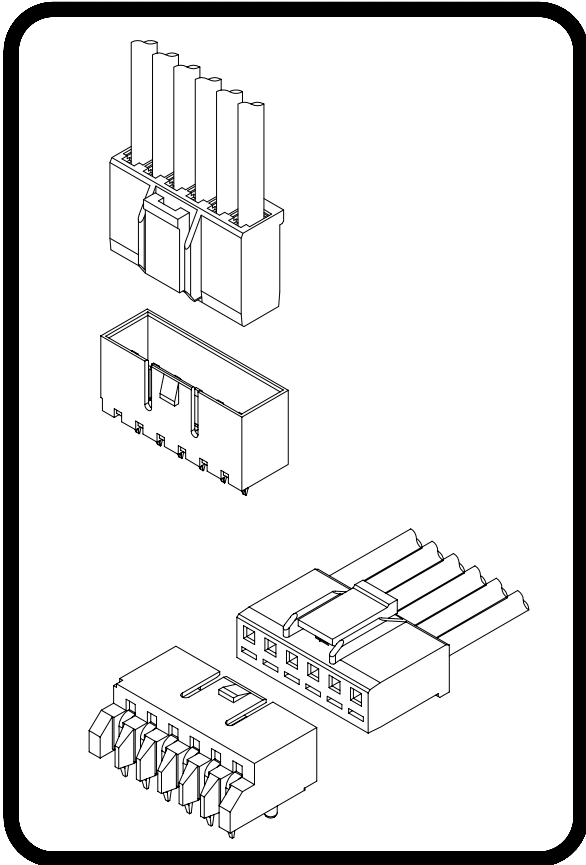

Assembly layout

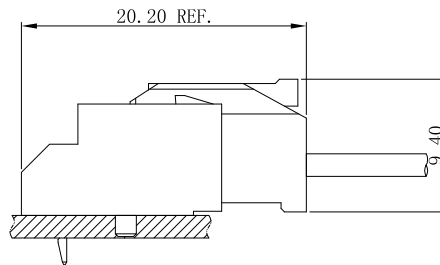
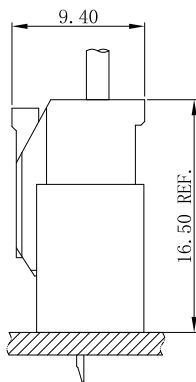

JVT3502 SERIES

3.5mm pitch wire to board connector

JVT3502H

3.5mm Pitch housing

HOUSING

Part No. : JVT3502HNO-XXL

Material: Nylon 66 UL94V-0

Mates With Part(s) : JVT3502 Terminal

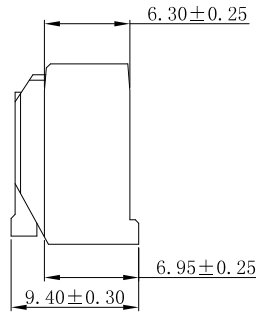
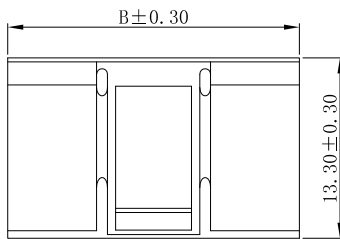
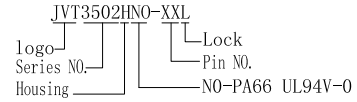
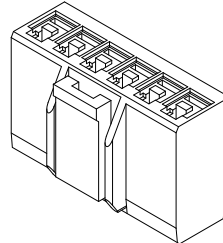
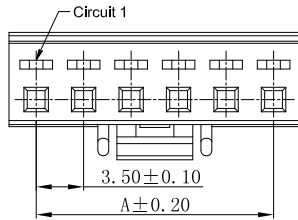

Circuits	Dimensions(mm)	
	A	B
2P	3.50	7.50
3P	7.00	11.00
4P	10.50	14.50
5P	14.00	18.00
6P	17.50	21.50
7P	21.00	25.00
8P	24.50	28.50
9P	28.00	32.00
10P	31.50	35.50
11P	35.00	39.00
12P	38.50	42.50
13P	42.00	46.00
14P	45.50	49.50
15P	49.00	53.00

JVT3502T

3.5mm Pitch Crimp Terminal

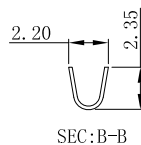
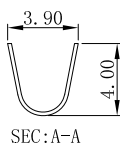
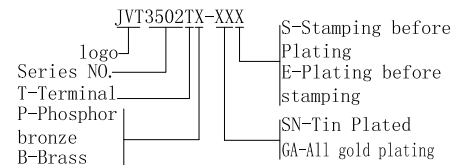
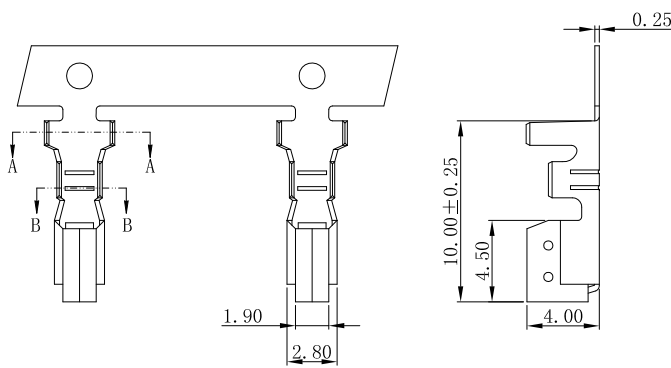

JVT3502TB-GAX	Brass	Gold Plated	AWG#22~26	3.0mm(Max)	JVT3502 HOUSING
JVT3502TB-SNX		Tin Plated			
JVT3502TP-GAX	Phos Bronze	Gold Plated	AWG#22~26	3.0mm(Max)	JVT3502 HOUSING
JVT3502TP-SNX		Tin Plated			
PART NO	Material	Finish(Pin)	Wire Range	Insulation O.D.	Mates With Part(s)

JVT3502 SERIES

3.5mm pitch wire to board connector

JVT3502W

3.5mm Pitch Wafer-DIP TYPE

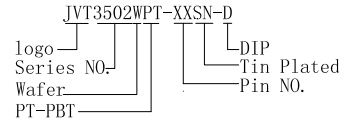
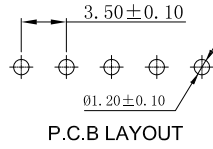
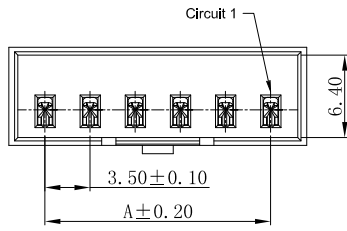

Circuits	Dimensions(mm)	
	A	B
2P	3.50	9.10
3P	7.00	12.60
4P	10.50	16.10
5P	14.00	19.60
6P	17.50	23.10
7P	21.00	26.60
8P	24.50	30.10
9P	28.00	33.60
10P	31.50	37.10
11P	35.00	40.60
12P	38.50	44.10
13P	42.00	47.60
14P	45.50	51.10
15P	49.00	54.60

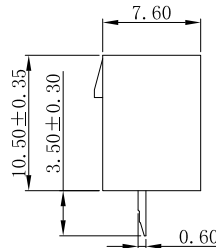
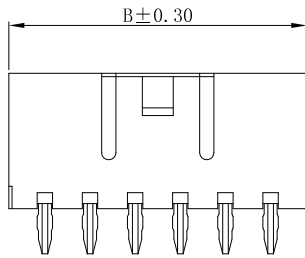

JVT3502WPT-XXSN-D	PBT UL94V-0	Brass	Tin Plated	JVT3502 Housing
PART NO	Material	Material(Pin)	Finish(Pin)	Mates With Part(s)

JVT3502W

3.5mm Pitch 90°Wafer-DIP TYPE

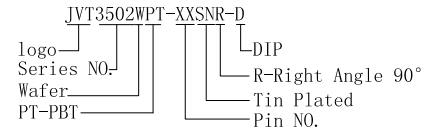
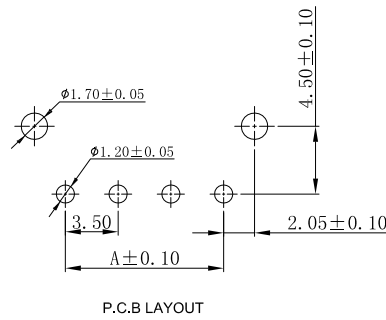
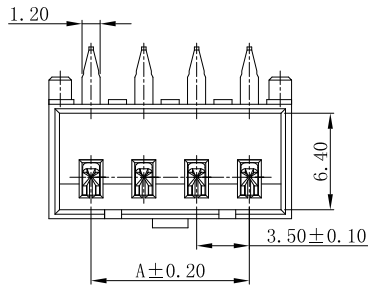

Circuits	Dimensions(mm)	
	A	B
2P	3.50	9.10
3P	7.00	12.60
4P	10.50	16.10
5P	14.00	19.60
6P	17.50	23.10
7P	21.00	26.60
8P	24.50	30.10
9P	28.00	33.60
10P	31.50	37.10
11P	35.00	40.60
12P	38.50	44.10
13P	42.00	47.60
14P	45.50	51.10
15P	49.00	54.60

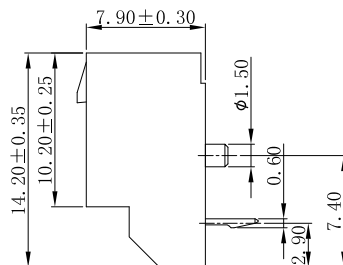
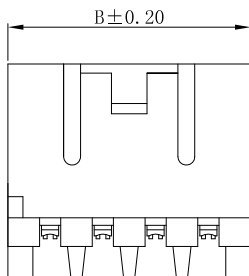

JVT3502WPT-XXSNR-D	PBT UL94V-0	Brass	Tin Plated	JVT3502 Housing
PART NO	Material	Material(Pin)	Finish(Pin)	Mates With Part(s)